

**Analysis of mineral oil:
„Manual“ pre-separation, followed by
LV-GC/FID
Off-line HPLC-GC/FID**

Christoph Hutzler

Topics

Design of the manual methods

Large Volume GC injections

CSR

Cool on-column

Validation data

Evaporisation / Enrichment

„Manual“ separation of MOSH and MOAH (SPE)

Development of the method

Validation data

Chromatograms (vs. LC-GC)

Offline-NP-HPLC

Principle

Pitfalls

Analytical Equipment used for analysis of mineral oil

- LC-GC (Brechtbühler)
- NP-HPLC (Agilent 1100)
- 2 GC-FID (Agilent 6890)

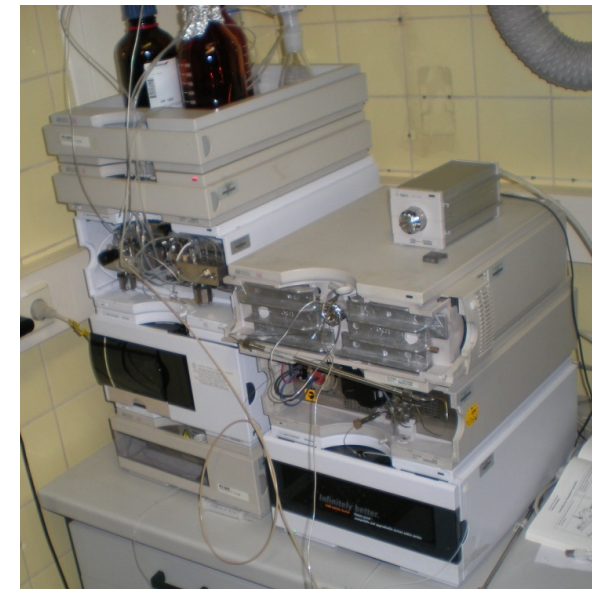

Challenges in analytics of mineral oil

Flame ionization detector (FID)

- The only detector with equal response for all hydrocarbons (Calibration!)
- **But**: low sensitivity, no selectivity
- GC-Analysis:

Necessary for differentiation to n-alkanes from biological sources

- Characterization of mineral oils is important → possible Information about the source of the contamination
- Broad humps of compounds.
→ MOSH and MOAH have to be separated from each other and from other disturbing compounds

Possible Interferences by Olefines (Terpenes, Squalenes und Carotinoides)

- Must be considered for MOAH.

Interferences by herbal paraffine

Design of the manual methods: Separation of MOSH and MOAH

- Samples are diluted by chromatographic separation of MOSH and MOAH
- Enrichment like at the LC-GC-Interface is missing for manual methods
 - Need for discrimination free enrichment of the sample
 - Need of large volume (LV) injection techniques
- Commercial available cartridges are often made of polyolefines (blank value - contamination!)
 - Need to use glass columns without turning valve (lubrication grease)
- Silica gel has to be activated
 - limited stability

Design of the manual methods: GC-parameters

- Fast temperature program: 15-25 °/min

→ Narrow and high humps

- Plane baseline (allows low attenuation)

→ Short analytical column (e.g. 10 m)

→ Small inner diameter of the analytical column (e.g. 0.25 mm I.D.)

→ Thin film of the stationary phase (e.g. 0.10 µm)

→ Apolar stationary phase with low bleeding (e.g. Dimethylpolysiloxane)

- High carrier gas flow, preferable hydrogen

→ Low temperatures for elution

Techniques for Large Volume (LV)-GC-injection

Cool On-Column

- Powerful, but allows no high boiling matrix
- With classical retention gap technique: 50 μ l
- With vapor exit up to 1000 μ l

Programmed Temperature Vaporizing (PTV)

- splitless 30 μ l
- solvent splitting: up to 500 μ l
- Cool on column adapters for different PTV

Hot Splitless (SSL)

- Concurrent Solvent Recondensation Technique (CSR): 50 μ l
- With vapor exit up to 1000 μ l

GC-FID: Techniques for large volume injection

- On-column
 - Retention gap technique: 50 μ l
 - with vapor exit : 300-1000 μ l

On-column injection

Slow injection of the sample onto the pre-column heated by the GC-oven.

No discrimination for the evaporation process.

Sensitive to non volatile residues.

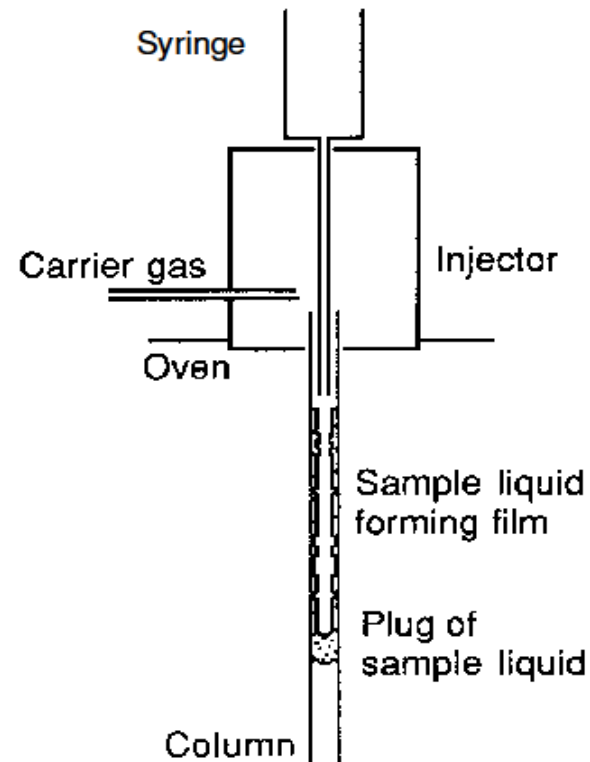

Large Volume Splitless Injection – Concurrent Solvent Recondensation (CSR)

- „Normal“ Splitless Injection:

Maximum Injection Volume (normally 1-2 μl) is determined by the Volume of the evaporation-chamber (= Liner), in which the vapor (mostly solvent) is stored for a short time.

- CSR

Transfer of the Vapor simultaneously to the evaporation, the vapor is not stored in The evaporation-chamber. A fast transfer of the vapor to the column is needed for that reason. The solvent-recondensation in the entrance of the precolumn is the driving force for the fast transfer.

Concurrent solvent recondensation large sample volume splitless injection. P. Magni and T. Porzano. J. Sep. Sci. 17 (2003) 1491-1498

Large volume splitless injection with concurrent solvent recondensation: keeping the sample in place in the hot vaporizing chamber. M. Biedermann, A. Fiscalini and K. Grob. J. Sep. Sci. 27 (2004) 1157-1165

CSR splitless injection

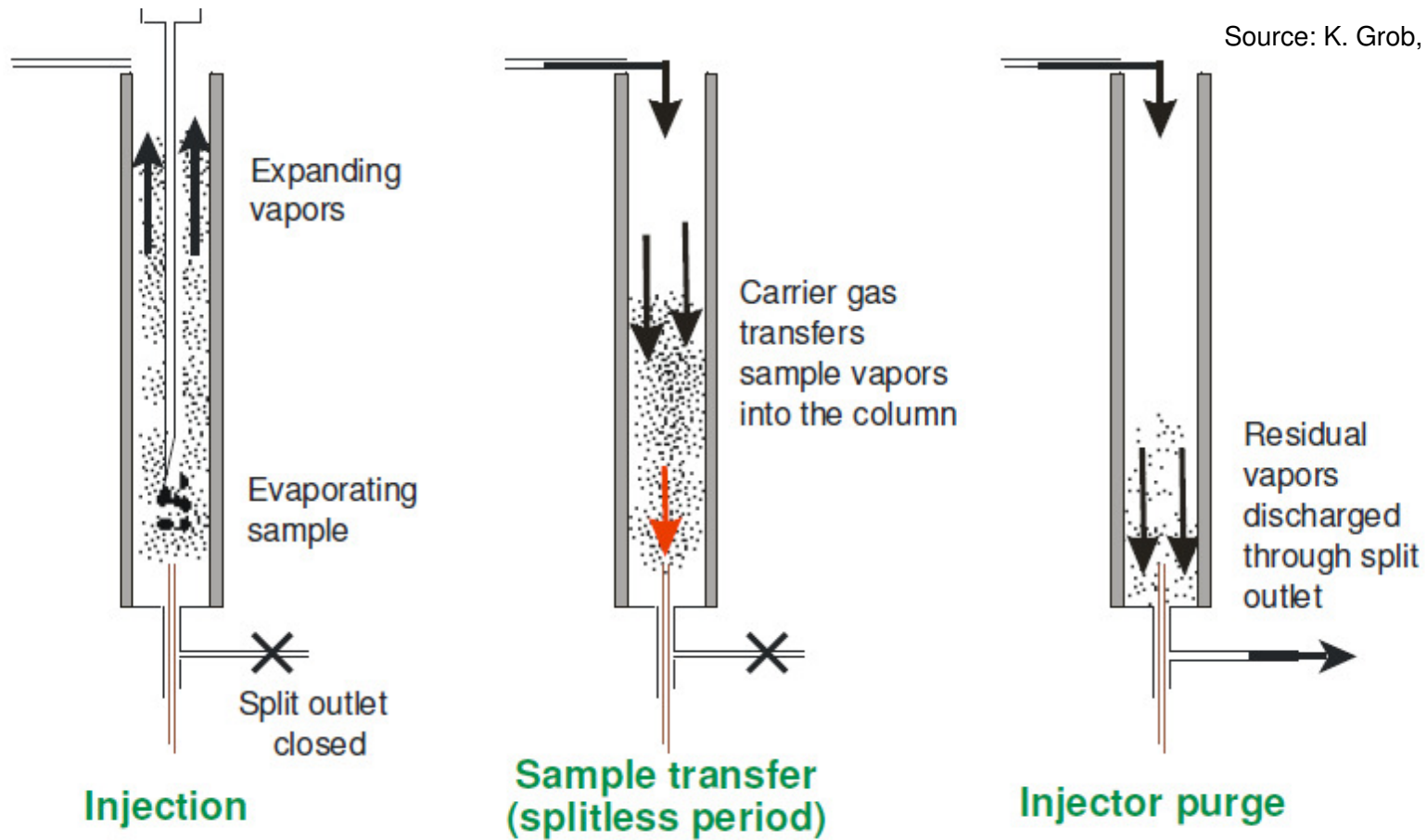

CSR splitless injection

Stopper for the liquid

- Stream of liquid routes itself to the bottom of the chamber
- Rejection from the hat chamber wall
- High speed, fast injection

- The stream of liquid has to be stopped and retained
- Glass wadding (fast cooling, low thermal mass)
- Easy to place in narrow, also in narrow sites

Large volume splitless injection with concurrent solvent recondensation: keeping the sample in place in the hot vaporizing chamber. M. Biedermann, A. Fiscalini and K. Grob. J. Sep. Sci. 27 (2004) 1157-1165.

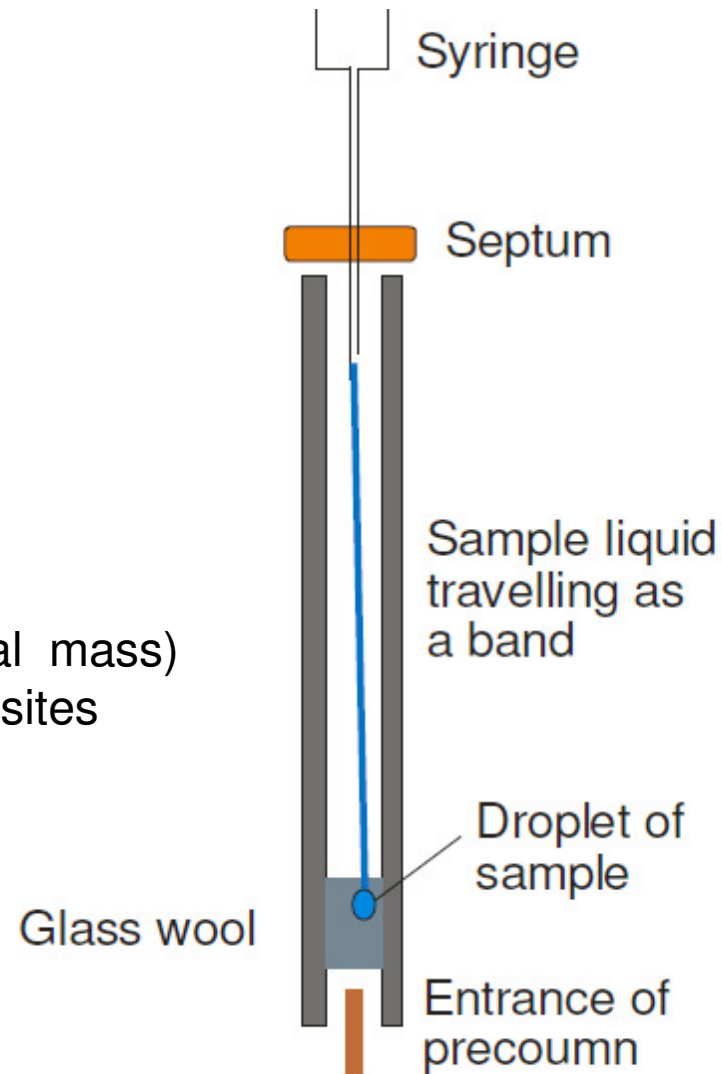

CSR splitless injection: requirements for a pressure increase

Source: K. Grob, Zürich 2010

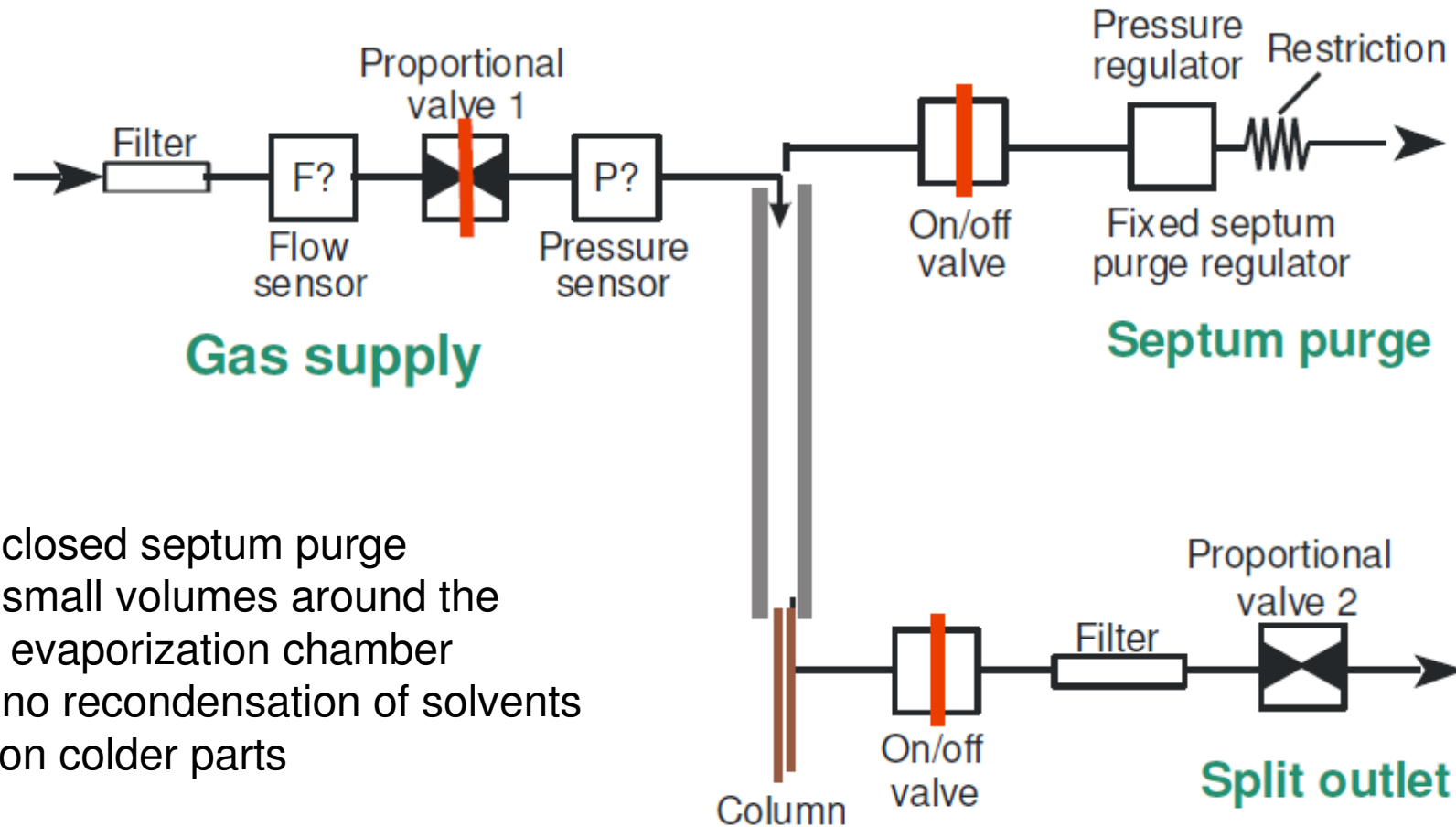

- closed septum purge
- small volumes around the evaporation chamber
- no recondensation of solvents on colder parts

CSR splitless injection: Feasible with our Agilent GC 6890 ?

Der Split/Splitless-Einlaß
Gasführung im Splitless-Modus

Abbildung 7. Flußdiagramm im Splitless-Modus, vom Pre-Run bis zur Purge Time

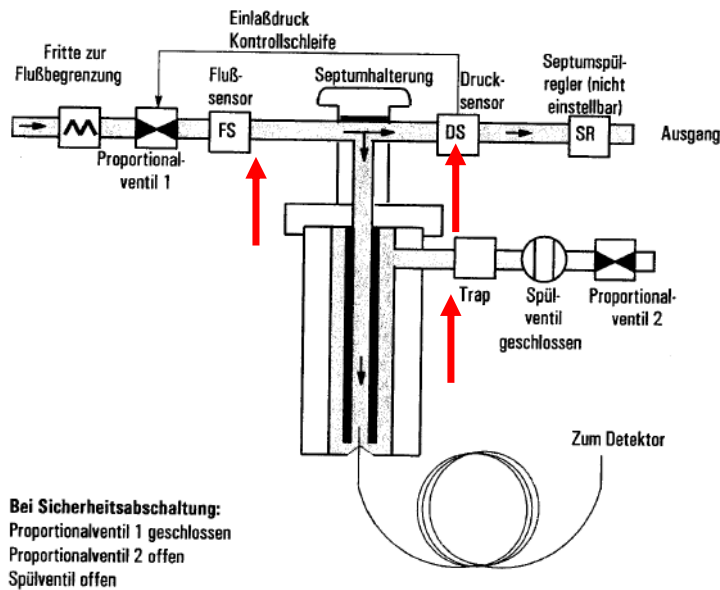

Source: Agilent manual GC 6890

Der Split/Splitless-Einlaß
Gasführung im Splitless-Modus

Abbildung 7. Flußdiagramm im Splitless-Modus, vom Pre-Run bis zur Purge Time

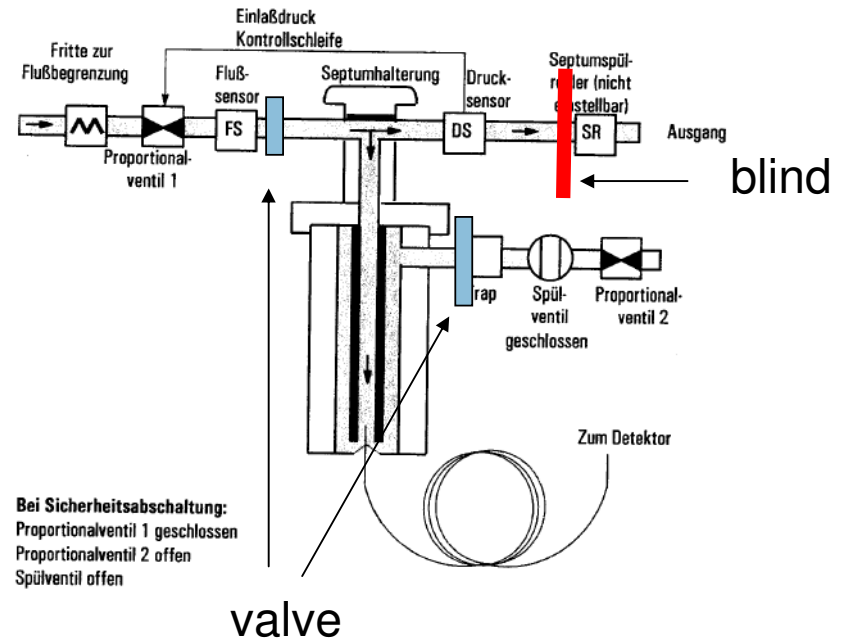

GC-conditions for cool on-column LV-injection

Carrier gas:	Hydrogen	FID-Detector:	
		Temp.:	365 °C
Injector:	cool on column	H ₂ :	40 mL/min
Volume:	40 µl	Syntetic air:	450 mL/min
Pressure:	24.4 kPa (H ₂)	Mode:	constant make up
Total flow:	45 ml/min (H ₂)	Makeup flow:	45 mL/min
		Makeup Gas Type:	Nitrogen
Oven:			
Start temperature:	75 °C (hold for 9 min)		
Ramp1:	22 °C/min to 240 °C		
Ramp2:	30 °C/min to 380 °C		
(hold for 12 min)			
Column:			
Precolumn	i.d. 0.53 mm, 7 m		
Analytical column	DB-1HT (15.0 m; 0.32 mm i.d., 10 µ)		
Mode:	ramp pressure		
Nominal init. pressure:	65 kpa for 3 min, then 35 kPa		

LV-GC-injection: cool on column vs CSR

On column: mix of n-alkanes, 40 μ l
0.5 μ g/ml (n-hexane/toluene 1:1)

CSR: mix of n-alkanes, 40 μ l
0.5 μ g/ml (n-hexane/toluene 1:1)

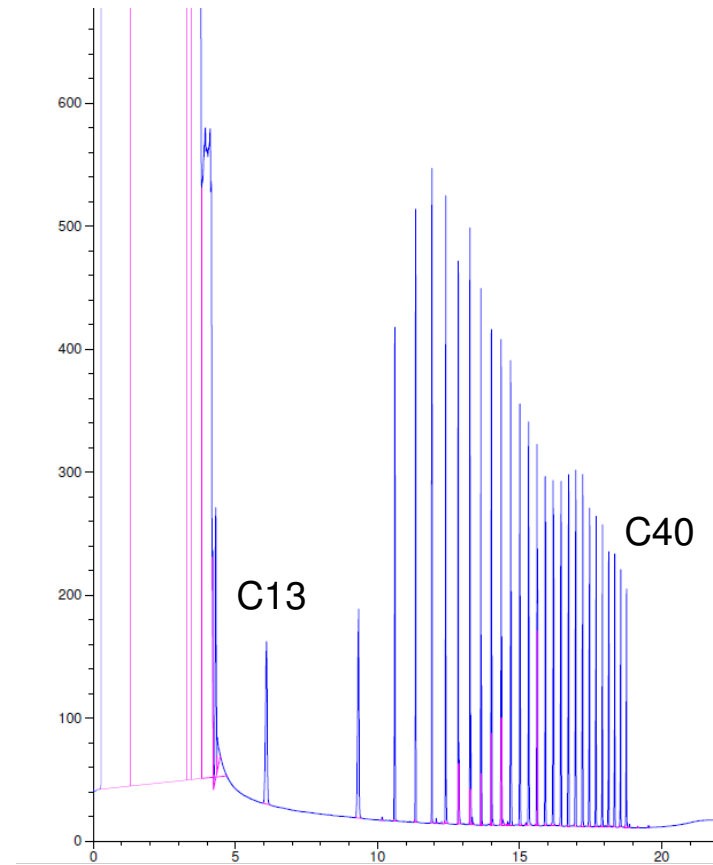
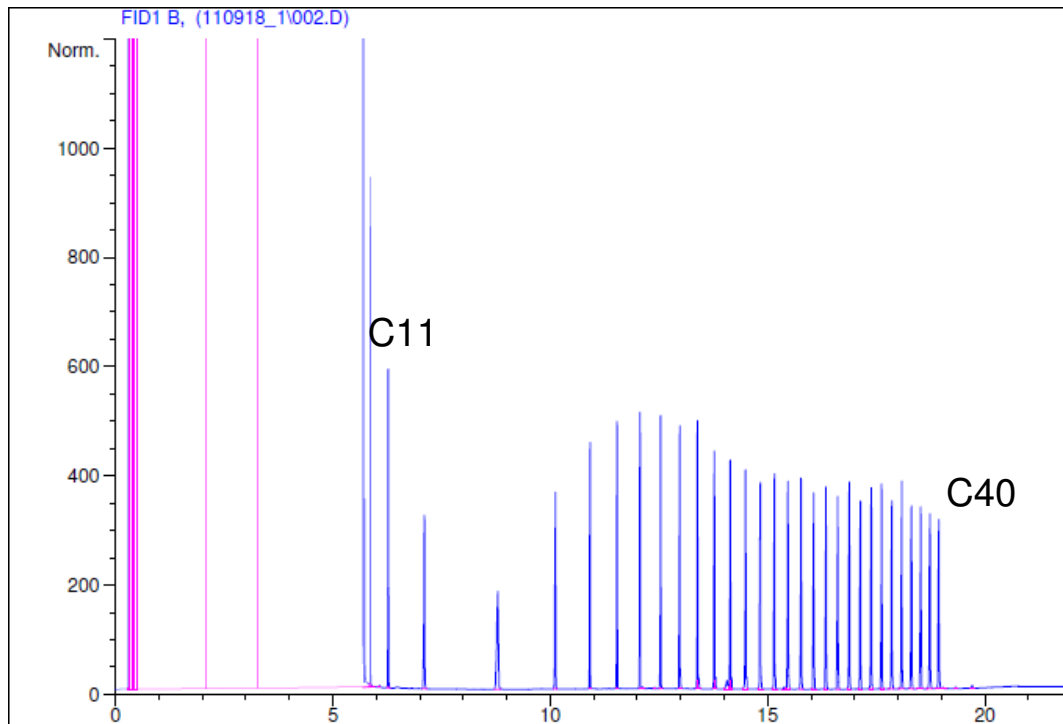

Validation of the LV-GC-method: Linearity with n-alkanes

Cool on-column, 40 μ l, carriergas H₂

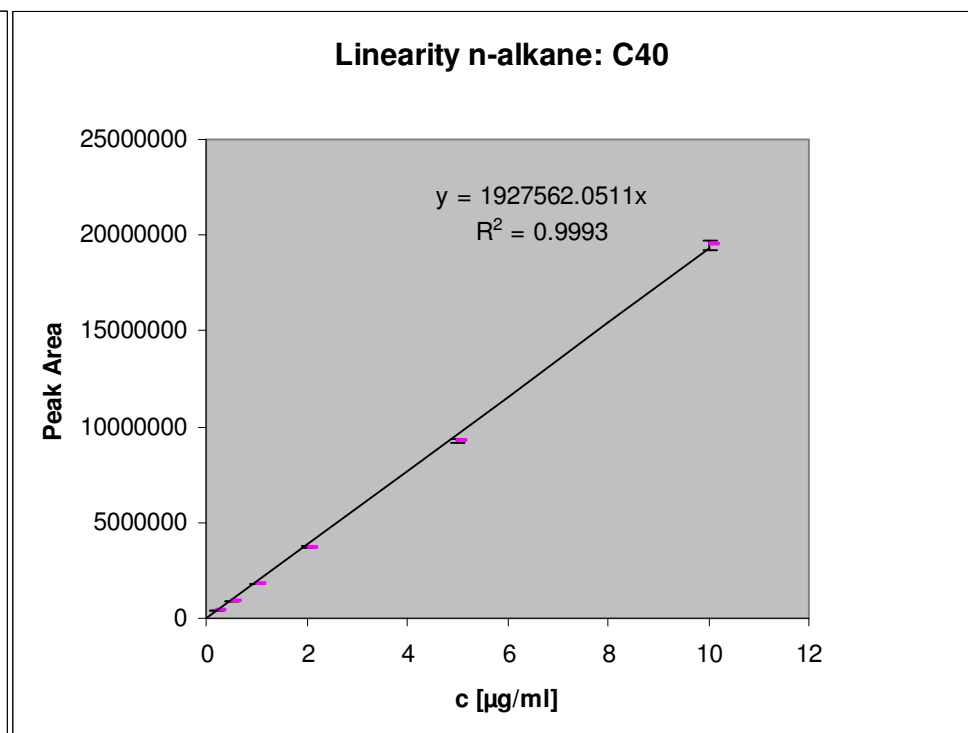
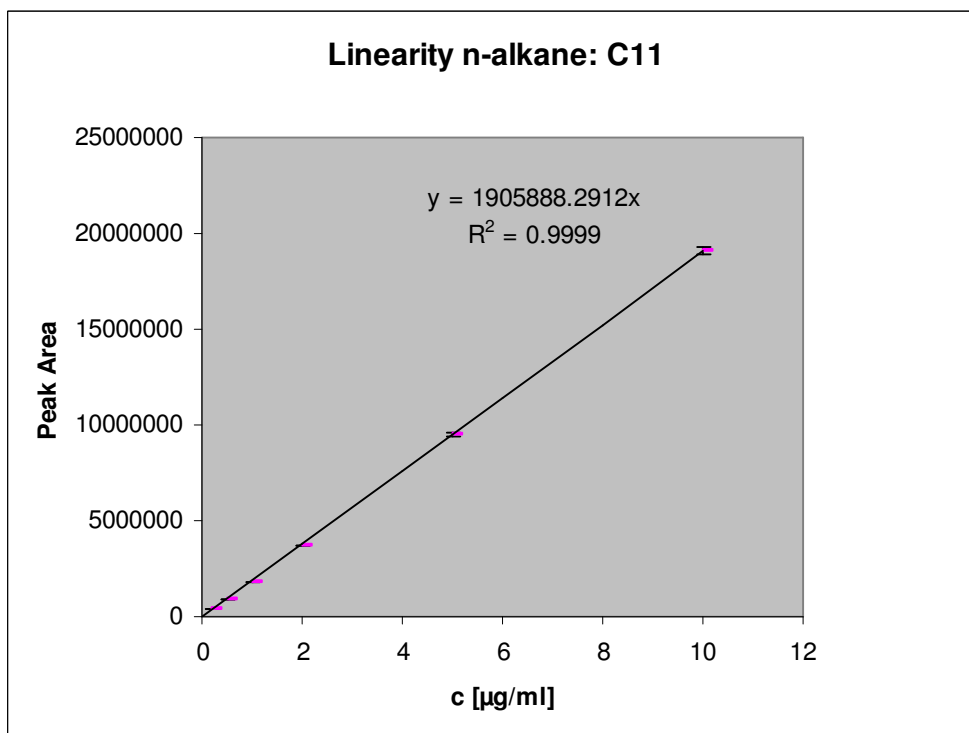
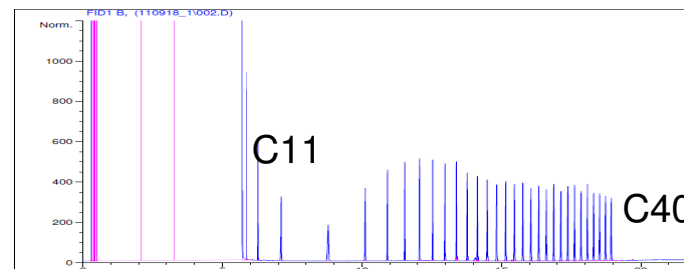

Validation of the LV-GC-method: Response for n-alkanes

**Cool on-column, 40 μ l,
carrier gas H₂**

Equal Response for n-alkanes

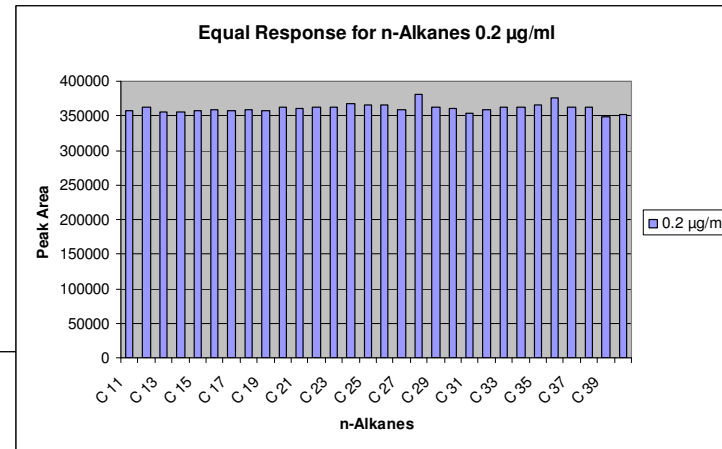
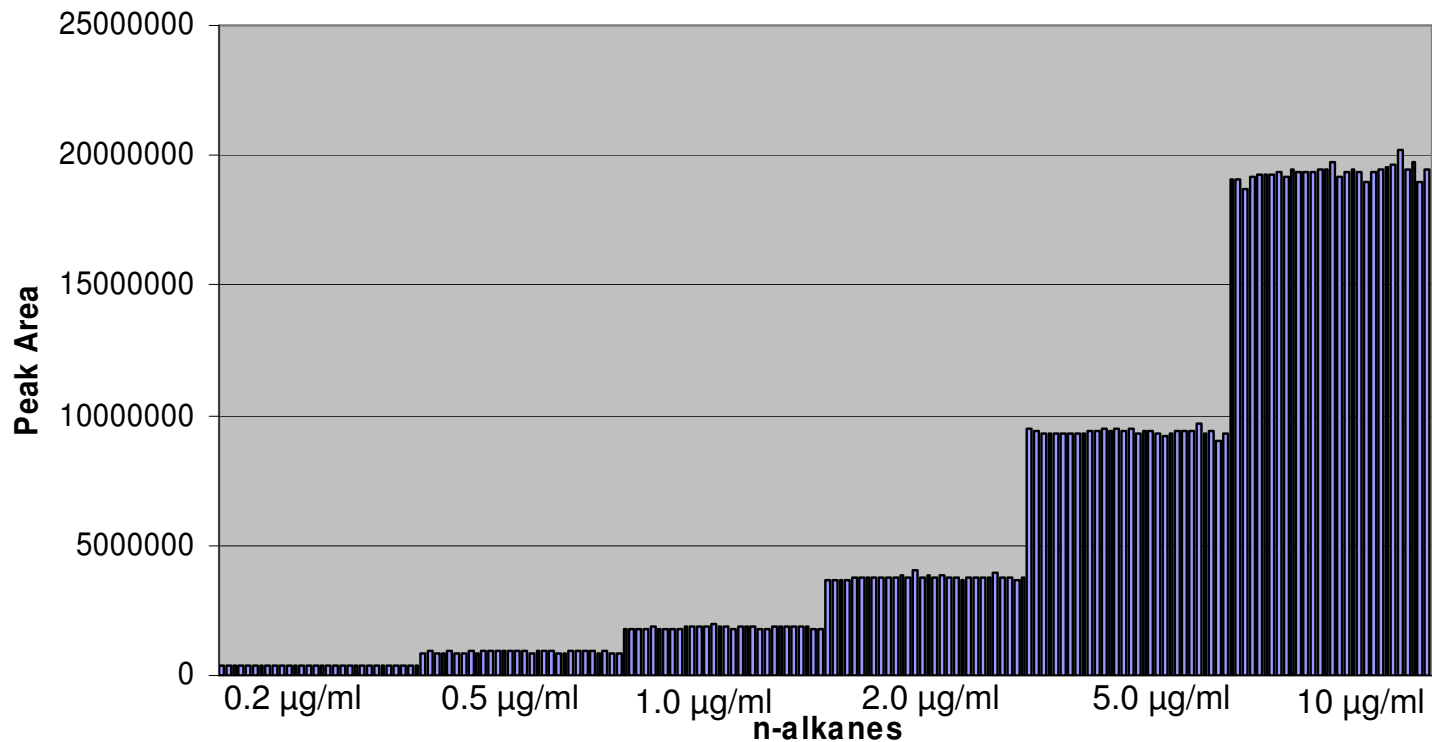

Validation of the LV-GC-method: Response for n-alkanes

Cool on-column, 40 μ l injection volume, carrier gas H₂

Mix of n-alkanes, conc. = 1 μ g/ml for each

Cv below 2% for every analyte from C11 to C40 from 0.2 – 10 μ g/ml

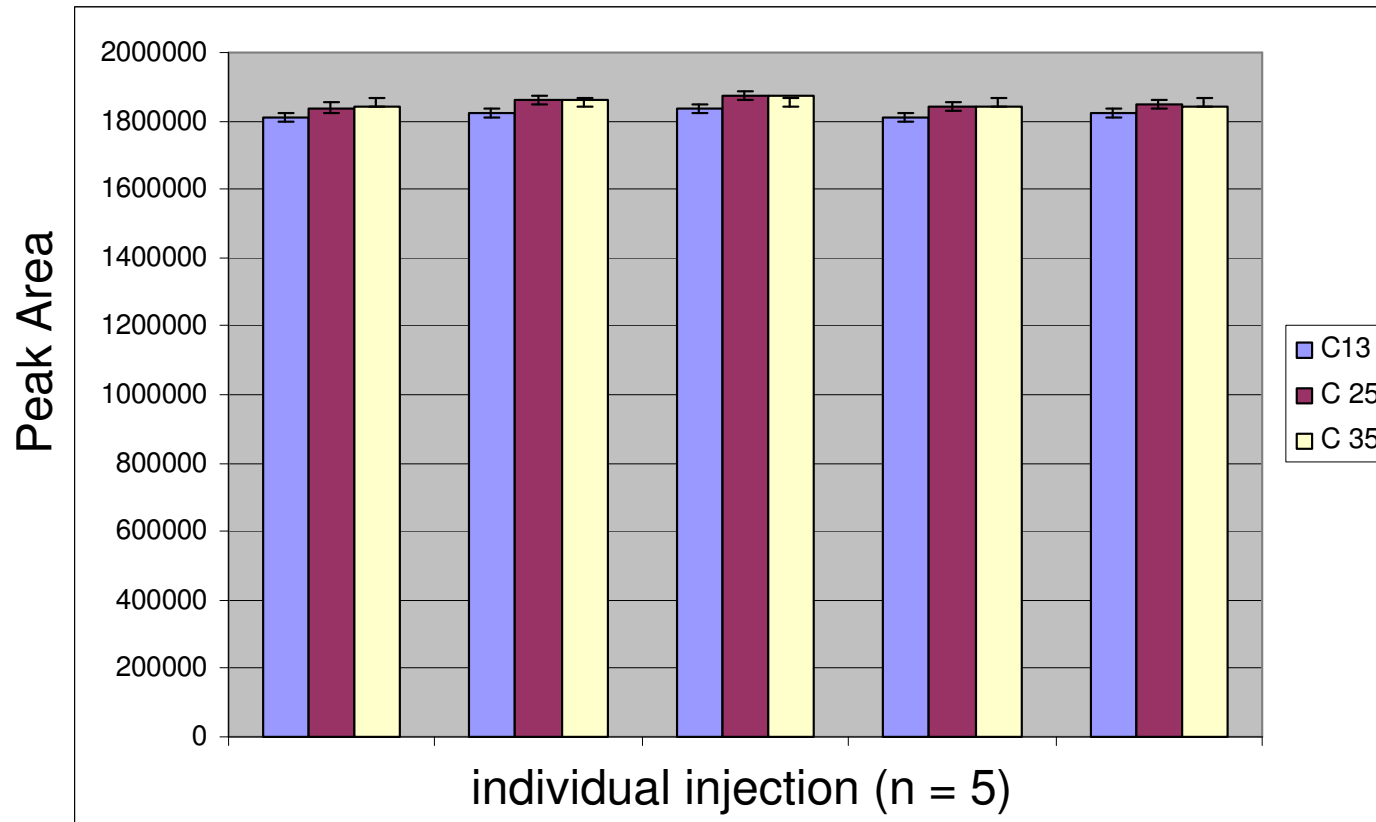

Validation of the LV-GC-method: linearity and Cv with mineral oil

Cool on-column, 40 µl, carrier gas H₂

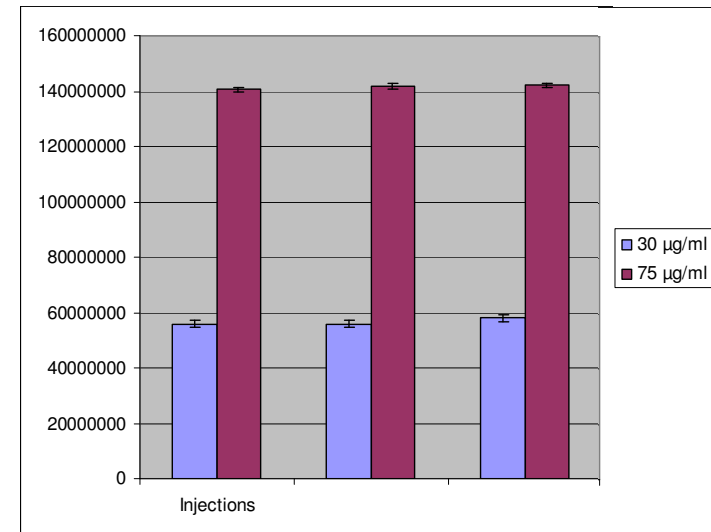
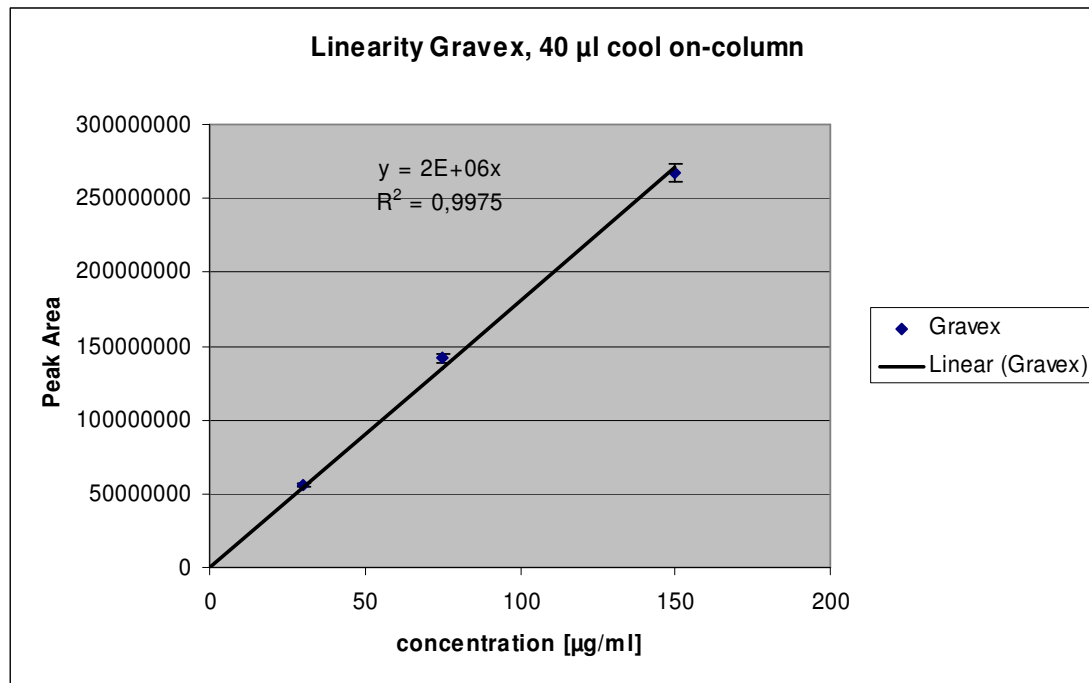

“Manual“ pre-separation by SPE: Evaporisation and enrichment of the samples

- MOSH and MOAH-fraction have to be evaporated to 200 to 300 μL .
- 270 μL toluene have to be added to the MOSH-fraction.
- Toluene has to be pre-cleaned on 0.3 % $\text{AgNO}_3/\text{Silicagel}$
- For concentration a rotary evaporator system is used in two steps:
Water bath temperature: 55 $^\circ\text{C}$

	Time [min]	Vacuum [mbar]
1. Step	3.0	520 – 530
2. Step	3 – 4	350 – 360

- Use of a teflon tubing and an additional glass liner.
- Clean the rotary evaporator system every working day with hexane.
- At least 2 blank values in every series: flask with hexane/toluene.
- The concentrated samples are transferred with a baked out glass pipette into the baked out autosampler vial.

Validation of the evaporation: Rotary evaporization system

Peak Area for n-alkanes

Cool on-column, 40 μ l, carrier gas H₂

270 μ l toluene + 5 ml n-hexane solution

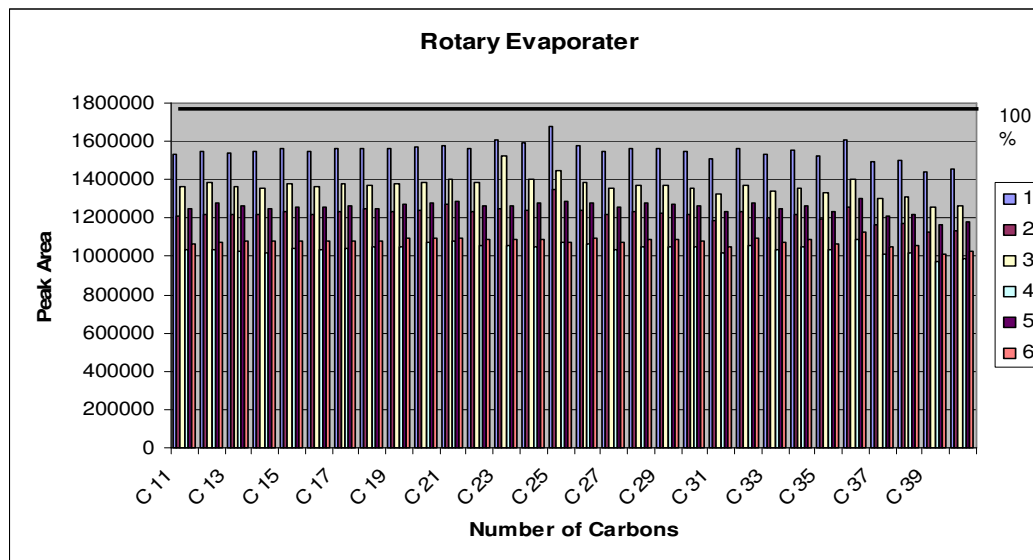

n=6

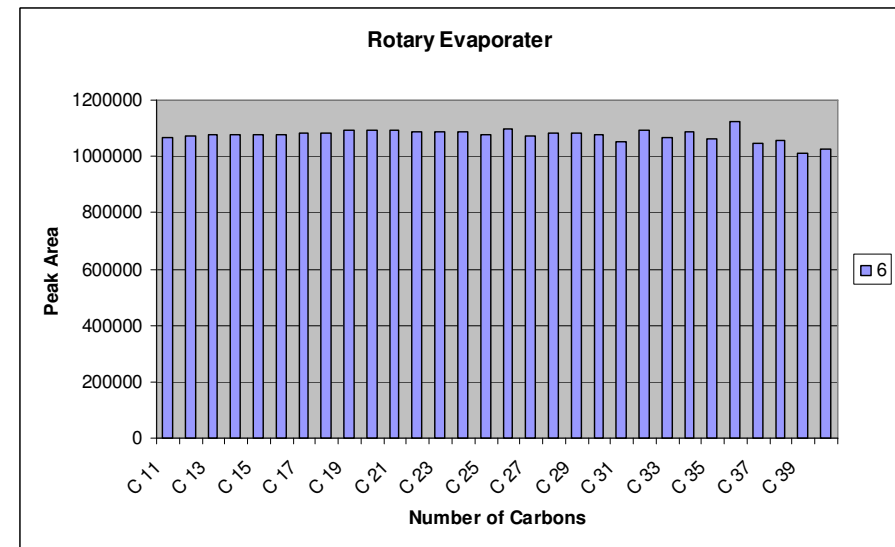

Single Experiment

- > no discrimination between C11 and C 40
- > variation of the concentrations

Validation of the evaporisation: Turbo® VAP and IR-Dancer

Cool On-Column, 40 µl, carrier gas H₂

45 °C, 2 kPa, 19 min

300 µl n-alkane-mix + 5 ml n-hexane +
270 µl toluene

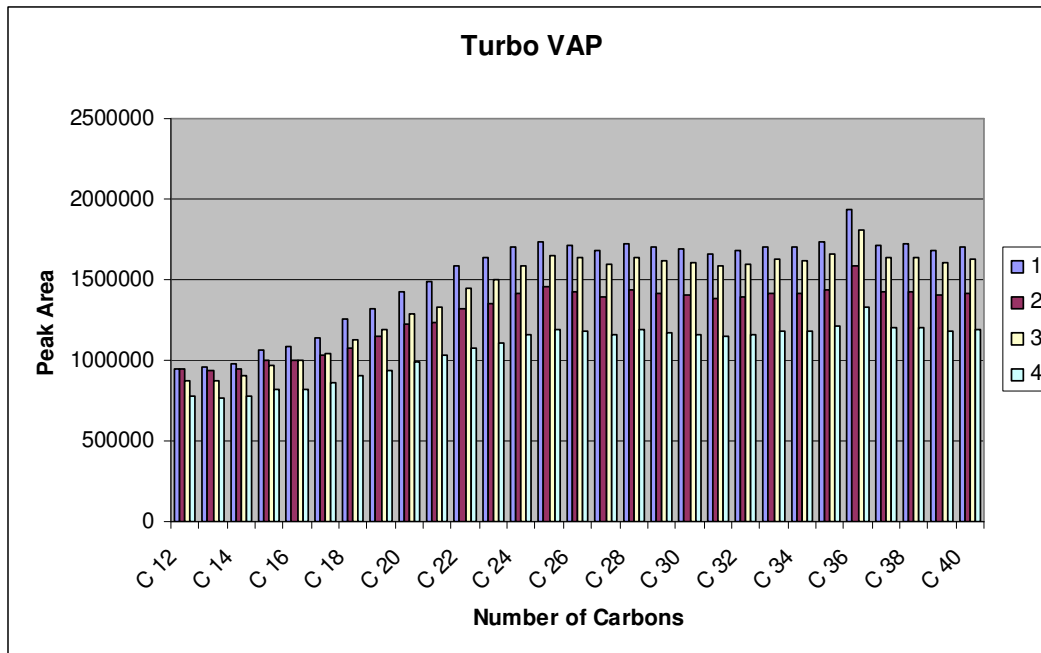

45 °C, 400 hPa, 2h

300 µl n-alkane-mix + 5 ml n-hexane +
270 µl toluene

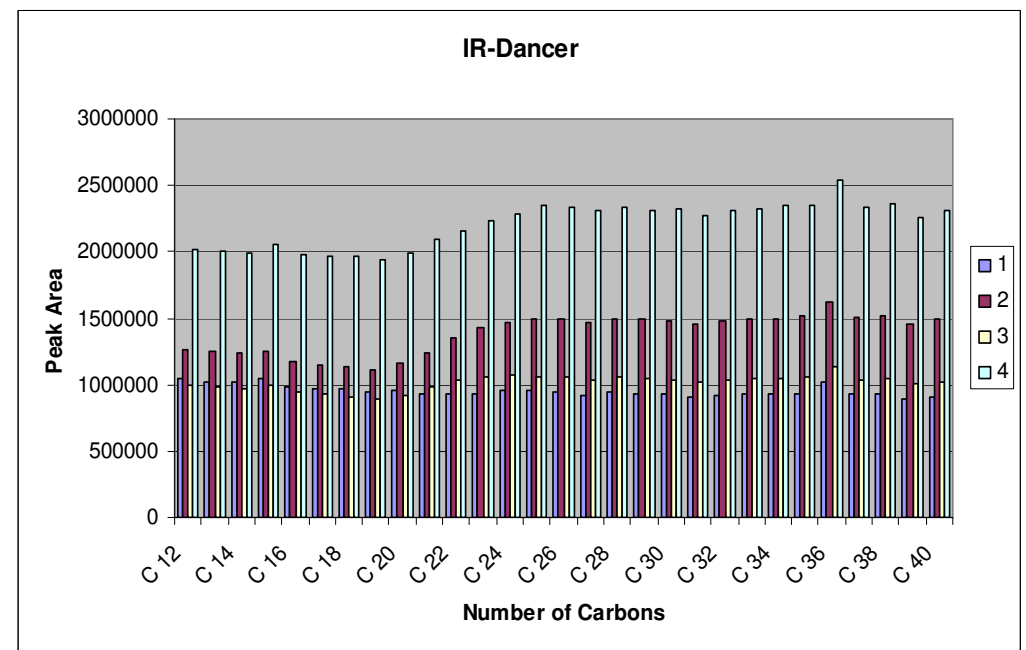

- > discrimination of more volatile compounds
- > variation of the concentrations

- > no discrimination
- > variation of the concentrations

Chromatographical Challenge

MOSH MOAH
Paraffine, alkylated benzenes
Naphthene alkylated polycycles Wax esters

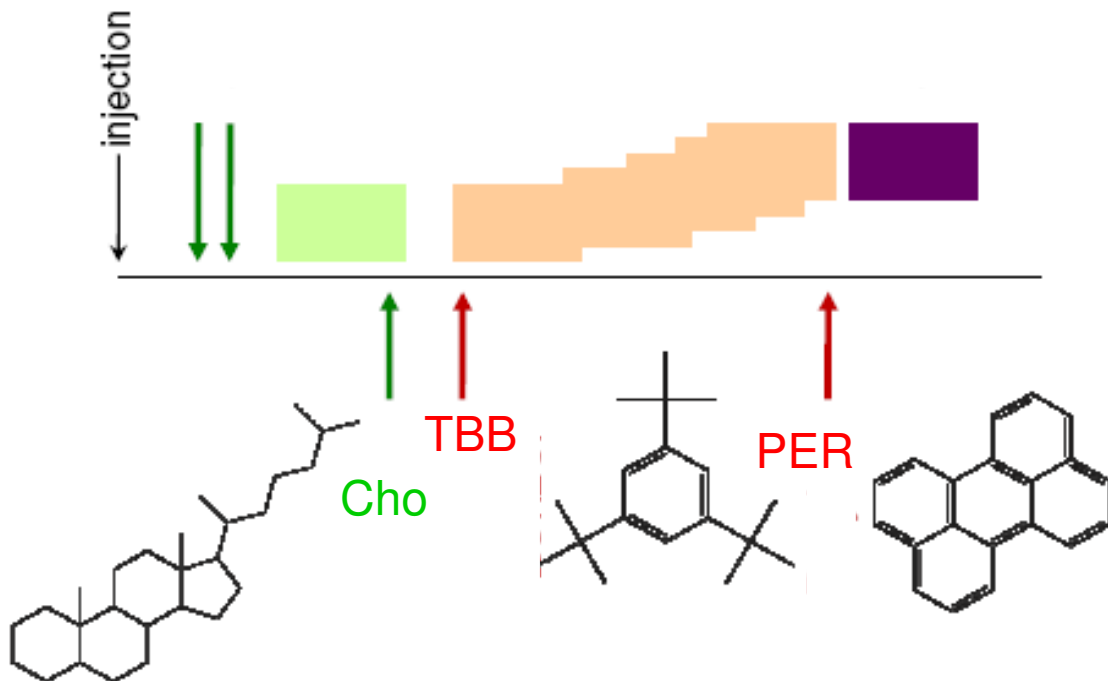

- Paraffine
- Naphthenes
- Highly alkylated benzenes
- Last MOAH: Perylene

Development of the method with standards.:

- Cholestane (Cho) - tri-tert. Butyl Benzol (TBB)
- Perylene (Per) – saturated wax esters separate: C18:C17-Ester (WE35) from MOAH

Step-gradient n-hexane / n-hexane + polar solvent

Source: Grob, Zürich 2010

“Manual“ pre-separation by SPE

- Use of a glass column (baked out for 24 h at 400 °C)
- Equipped with a fiber glass filter
- 3.0 g silica gel containing 0.3% AgNO_3 are transferred into the glass column

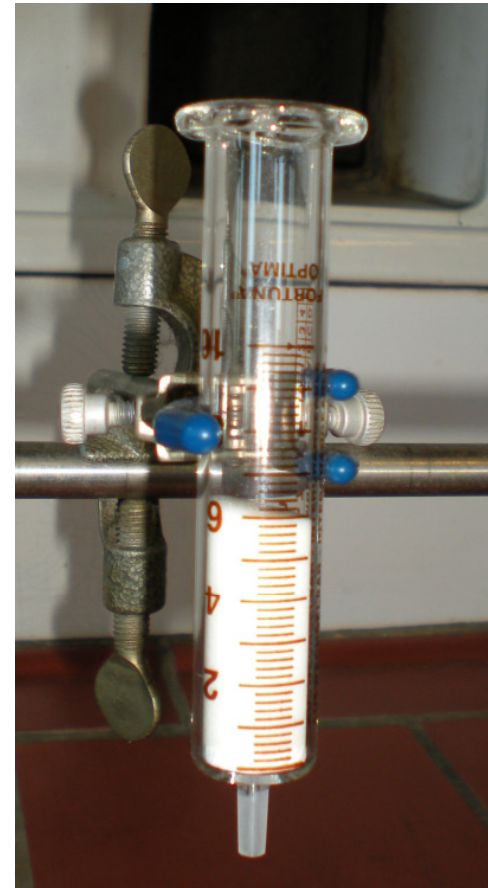
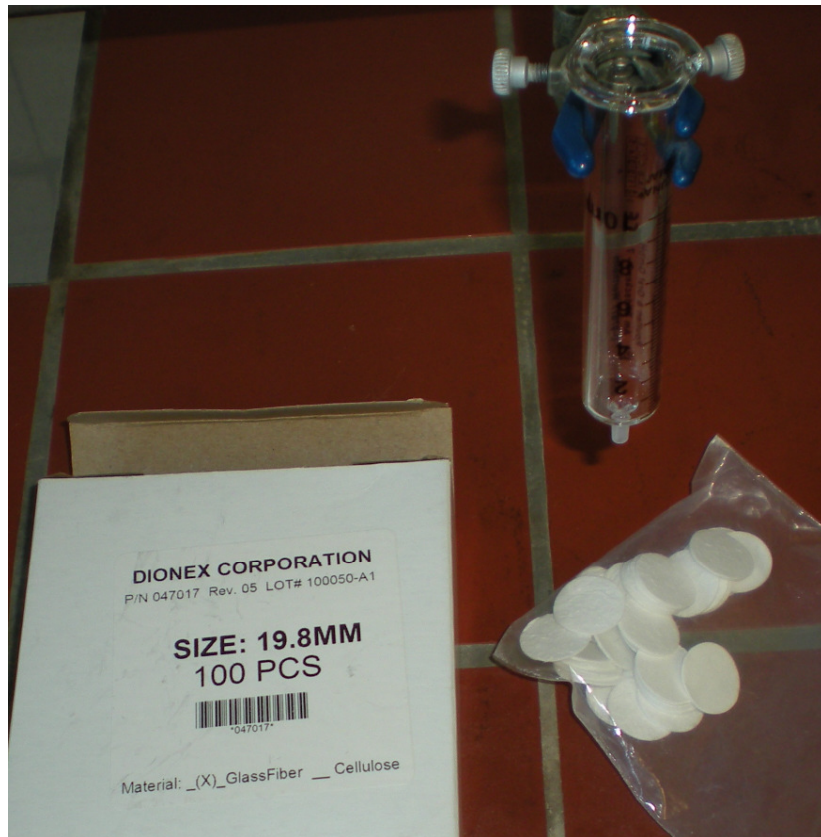

“Manual“ pre-separation by SPE

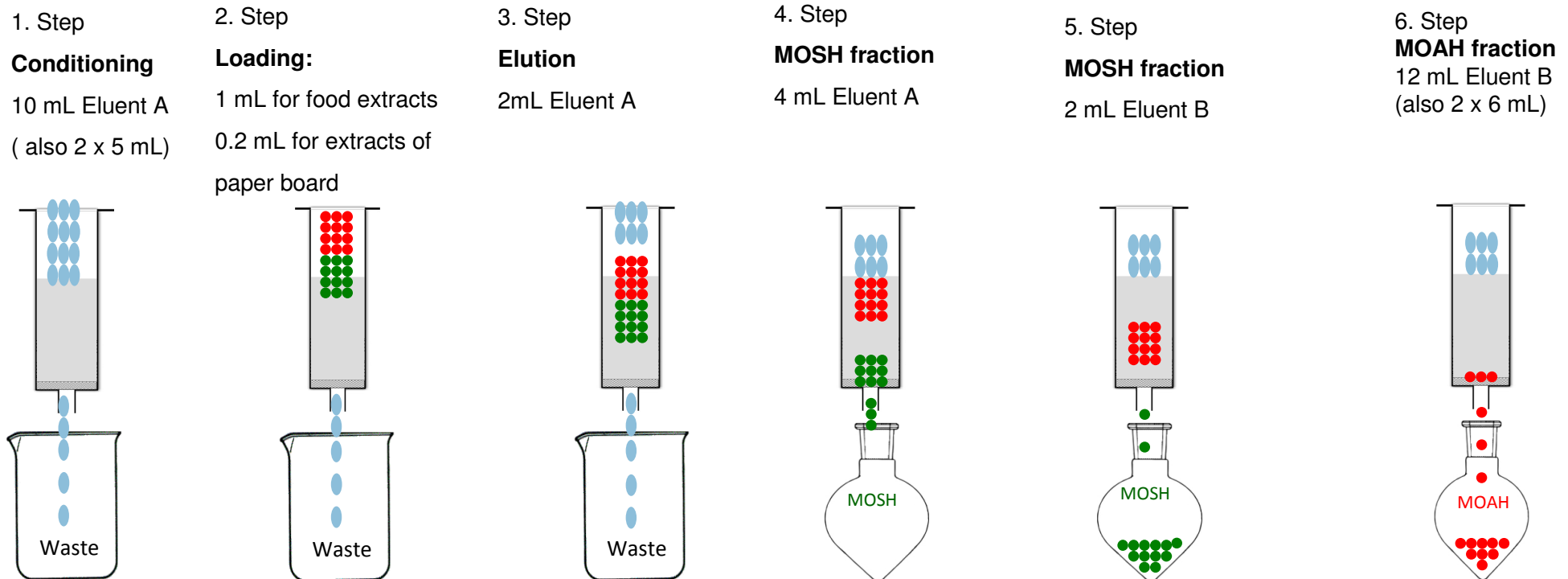

Eluent A: n-hexane

Eluent B: 5 mL toluene + 20 mL DCM ad 100 ml n-hexane

“Manual“ pre-separation by SPE: Silica gel with AgNO₃

Silica gel containing 1 % AgNO₃

- 0.5 g AgNO₃ are dissolved in 50 mL deionised water.
- The solution is transferred into a round bottomed flask containing 49,5 g silica gel. Use a brown glass aluminum foil to avoid exposure to light.
- The water is removed for 1 h at 70°, 1 h at 80°C and finally for 12 h at 90°C in a laboratory-type drying cabinet. The silica gel has to be totally dry after this treatment.

Silica Gel containing 0.3 % AgNO₃

- 66 g highly activated silica gel (baked out at 400°C) is mixed with 33 g silica gel containing 1 % AgNO₃ for 12 h using a head over heels shaker.
- During mixing the used bottle has to be covered with aluminum foil to avoid exposure to light.

Note: The silica gel containing 0.3 % AgNO₃ can be used for two weeks while storing at room temperature in the dark.

Development of the SPE procedure (Solid Phase Extraction)

activated silica

1% AgNO₃

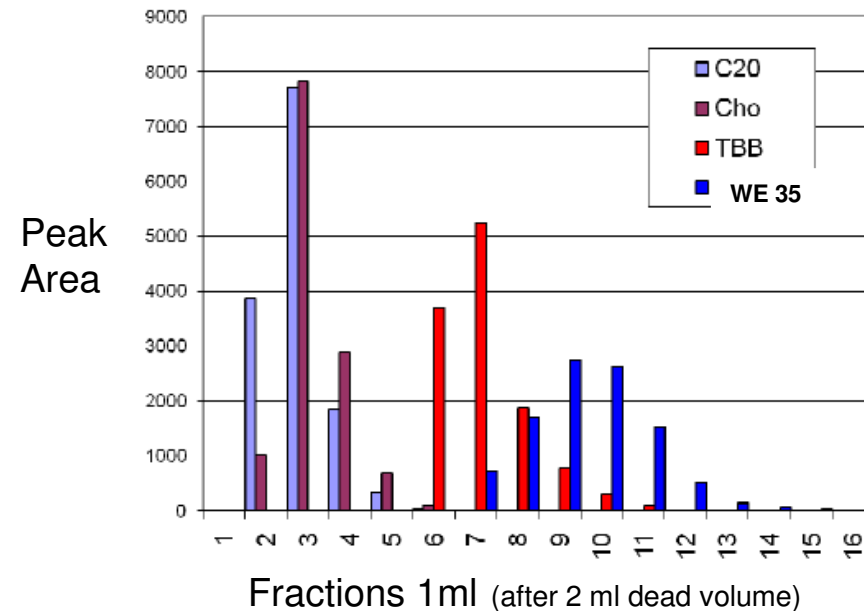
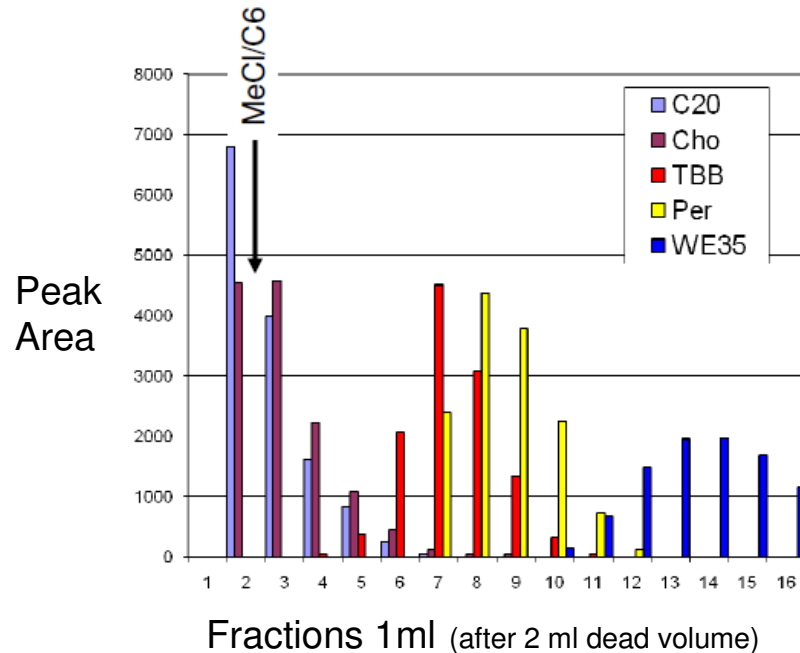

Experiment:

- silica gel 400 °C (act) / 24 h
- 50% DCM for MOAH starting from fraction 3

Result:

- Cho/TBB not efficient separated
- Per/WE35 inadequate separated

Experiment:

- silica gel 150 °C 1% AgNO₃
- 100% DCM for MOAH starting from fraction 3

Result:

- Cho/TBB ok
- **no Per, but WE 35**

Development of the SPE procedure

Use of toluene to elute the MOAH-fraction

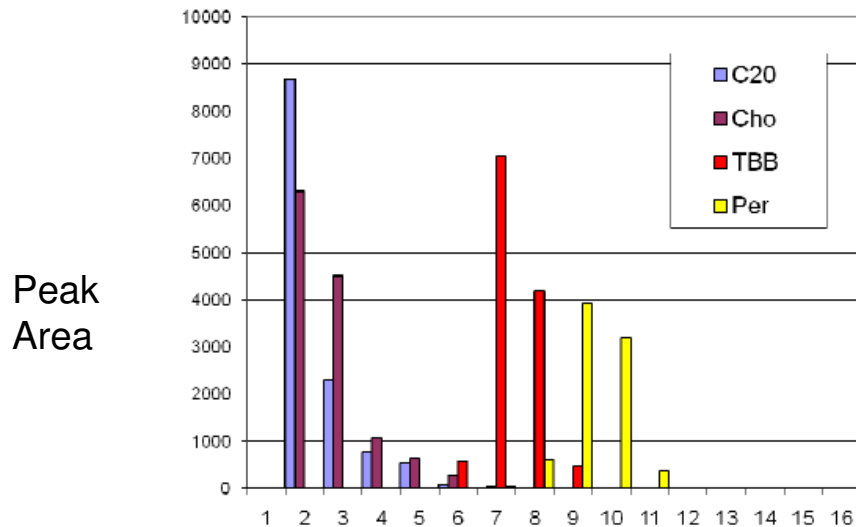

Fractions 1 ml (after 2 ml dead volume)

Experiment:

- silica gel / 0.1% AgNO₃
- 50% toluene for MOAH

Result:

- Cho/TBB narrow
- Per near to TBB
- no WE35

Gradient later

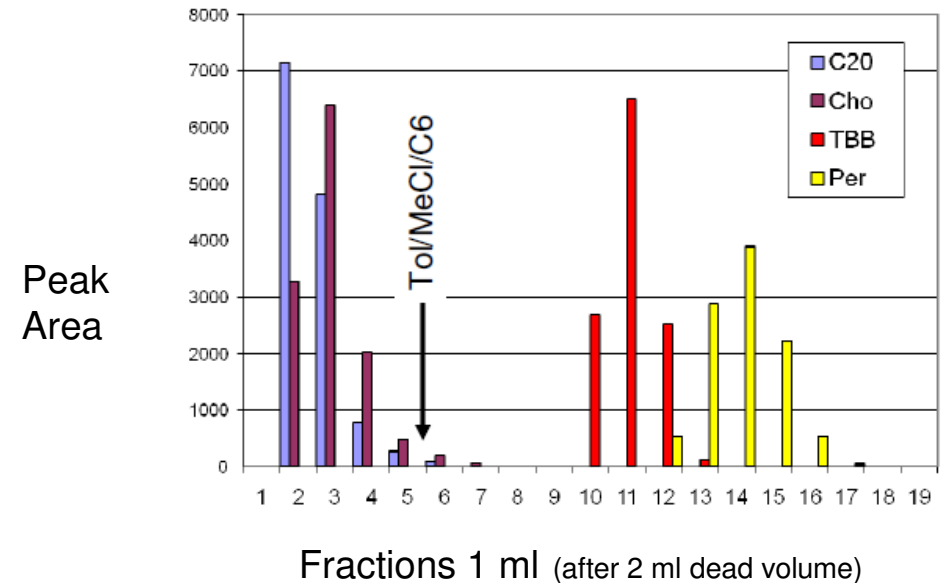

Peak Area

Fractions 1 ml (after 2 ml dead volume)

Experiment:

- silica gel 1% AgNO₃ + act silica gel 1 + 2
- 30 % toluene for MOAH starting from fraction 6

Result:

- Cho/TBB very good
- Per near to TBB
- no WE35

Problem: evaporation of toluene

Development of the SPE protocol

Partial replacement of toluene by DCM

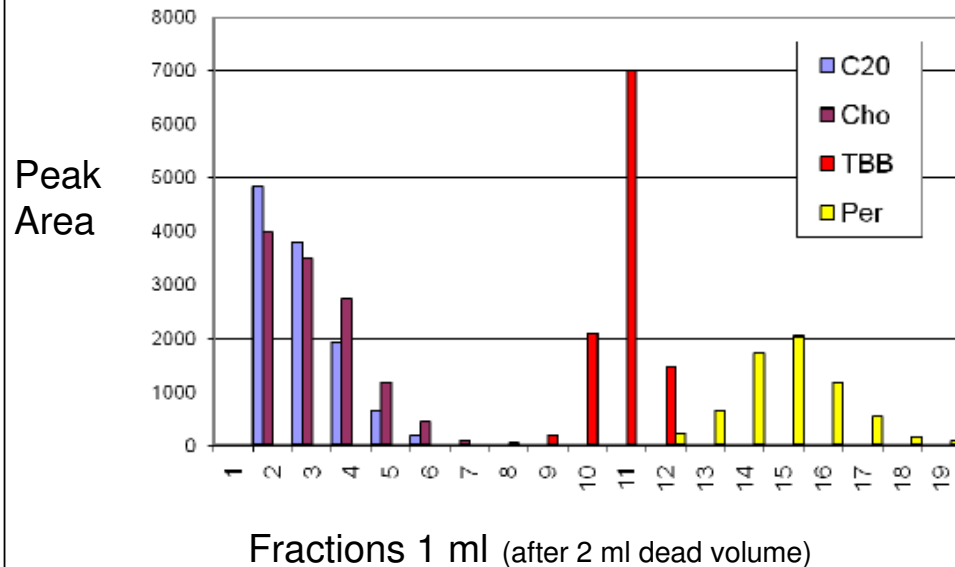

Experiment:

- silica gel 1% AgNO₃ + act silica gel 1 + 2
- 20 % DCM and 5% toluene for MOAH starting from fraction 6

Result:

- Cho/TBB ok
- Per broad
- no WE35

30% DCM

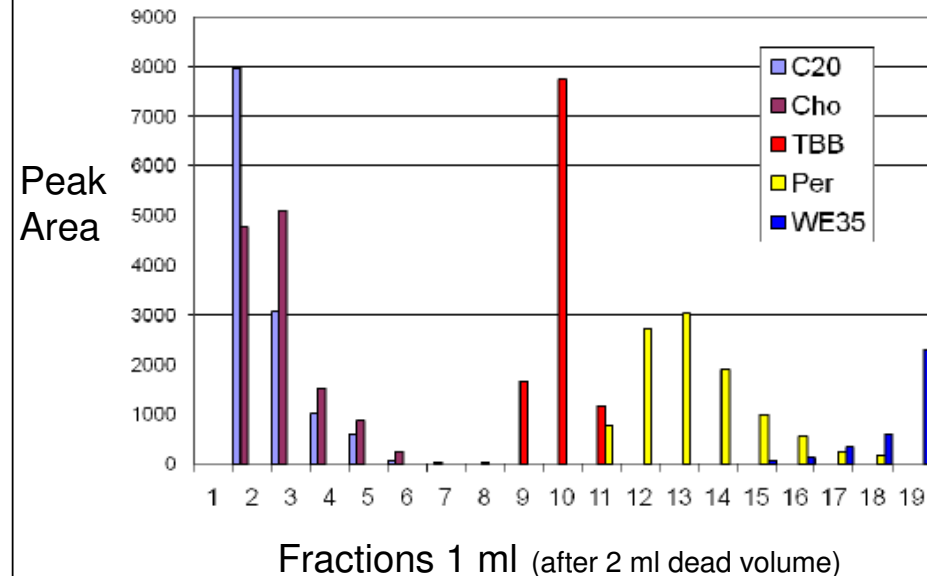

Experiment:

- silica gel 1% AgNO₃ + act silica gel 1 + 2
- 30 % DCM and 5%toluene for MOAH starting from fraction 6

Result:

- Cho/TBB good
- Per broad
- WE35 visible

Validation of the SPE-Method

Gravex 913 1000 ppm in n-hexane

Direct injection without SPE -separation

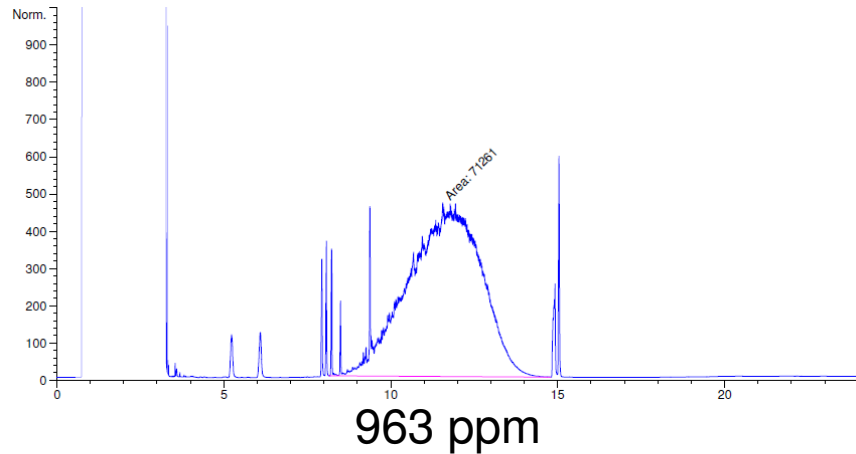

Recovery of 99.9% of the Gravex-Peak after SPE separation (n=4):

72.5 ± 0.5 % MOSH (LC-GC: 72.9)

27.5 ± 1.7 % MOAH (LC-GC: 27.1)

Recovery related to the initial weight: 96 %

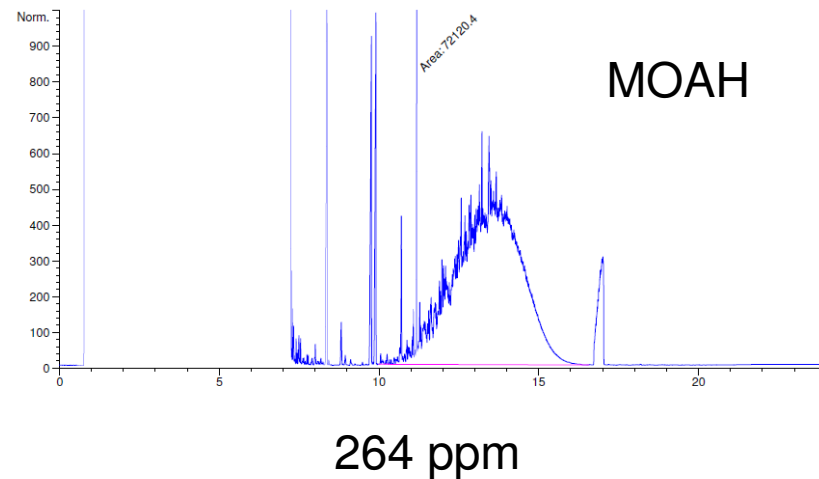
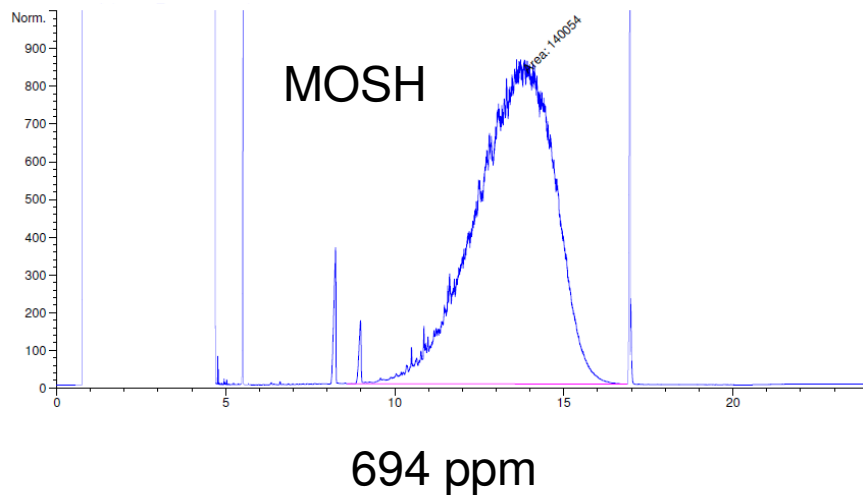

Extraction of samples

10 g dry food

10 ml n-hexane
10 µl IS-mix
12 h
1 ml auf SPE

2 g paper/paper board

10 ml n-hexane / EtOH (1:1)
20 µl IS-mix
12 h
4 ml extract is shaken with 10 ml water
0.2 ml upper phase on SPE

Capacity for fat: 200 mg

Validation of the SPE-method: internal standards (IS)

Old set of IS (Biedermann and Grob, 2010):

MOSH: n-C12	(C12)
n-C14	(C14)
n-C16	(C16)
Cholestane	(Cho)

MOAH: Hexyl benzene	(6B)
Nonyl benzene	(9B)
Tritert.butyl benzene	(TBB)
Biphenyle	(BP)
Perylene	(Per)

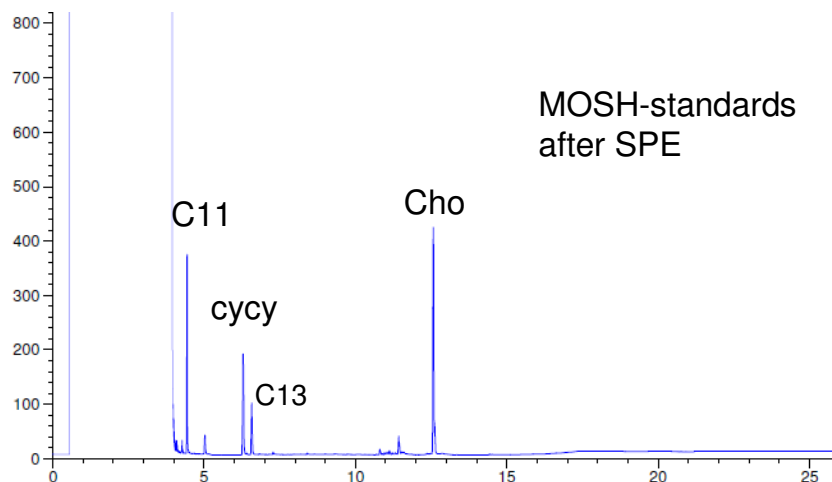

New set of IS:

MOSH: n-C11	(C11)
Bicyclohexyl	(cycy)
n-C13	(C13)
Cholestane	(Cho)

MOAH: Pentyl benzene	(5B)
1-Methyl naphthalene	(2MN)
2-Methyl naphthalene	(1MN)
Tritert.butyl benzene	(TBB)
Perylene	(Per)

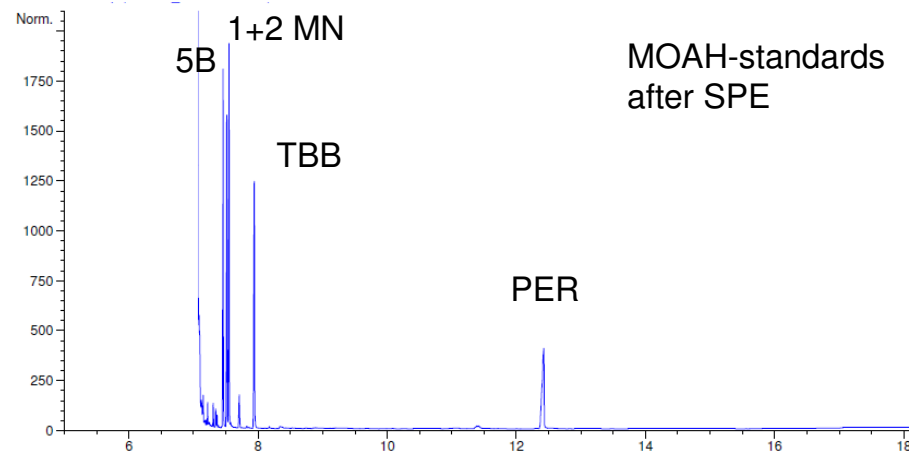

Use of commercial available silica gel containing AgNO_3

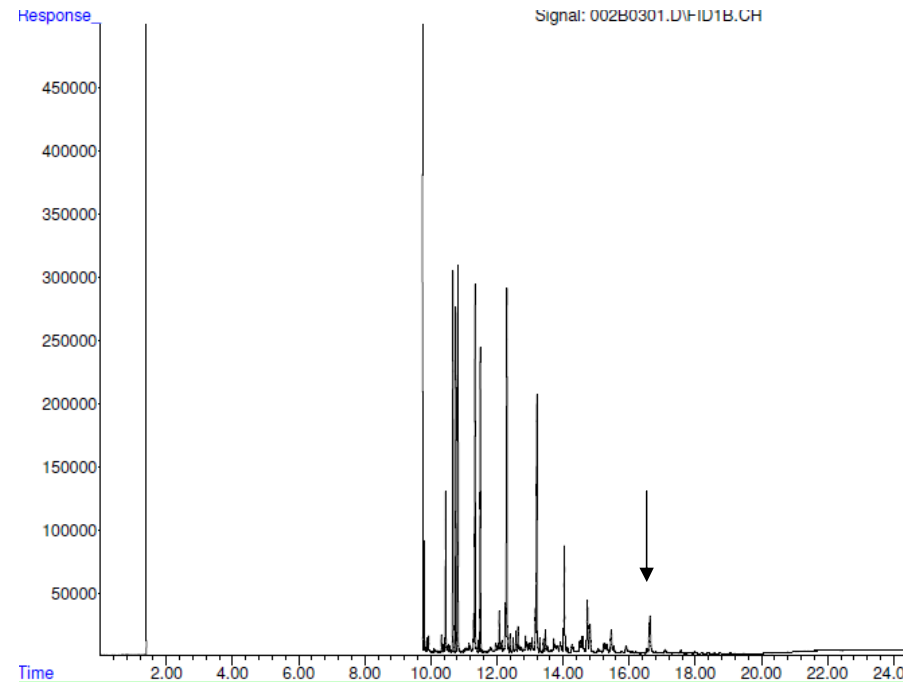
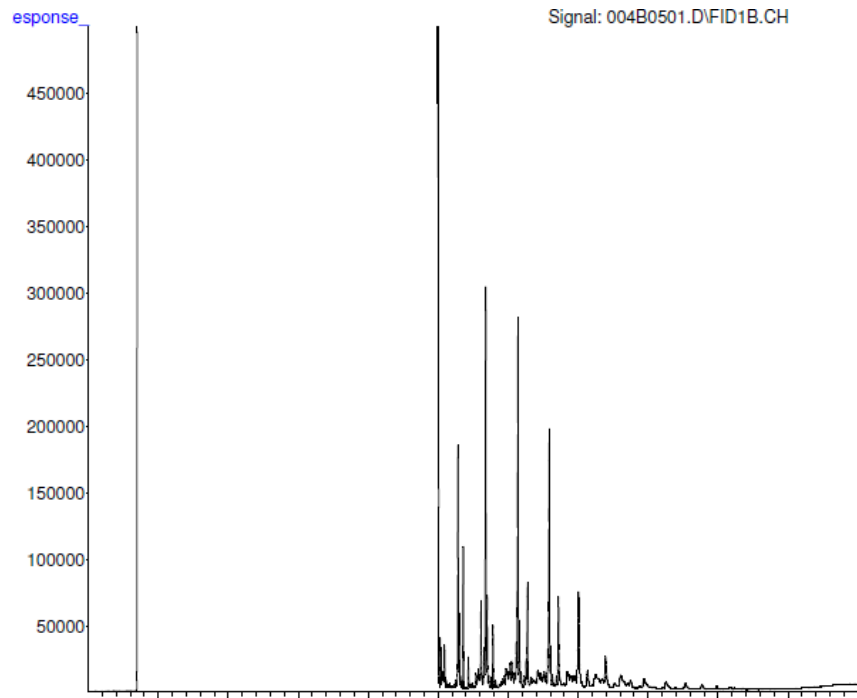

Extract of the silica gel with toluene/hexane

MOAH-Fraction after SPE

—————> Disturbing substances from the silica gel, from the caps ?

Validation of the SPE-method: further verification standards tested

MOSH: Alpha-homo-cholestane

→ not detected in MOAH-fraction

MOAH: Hexaethylbenzene (1)

→

1,4-Bis(2-Ethyl-hexyl)-benzene (2)

→

1,4-Bis(3,7-dimethyloctyl)-benzene (3) → → not detected in MOSH-fraction

1-Phenyloctadecane (4)

→

1,2,3,5-Tetracyclohexylbenzene (5)

→

Chromatogram of MOAH-fraction
after SPE separation

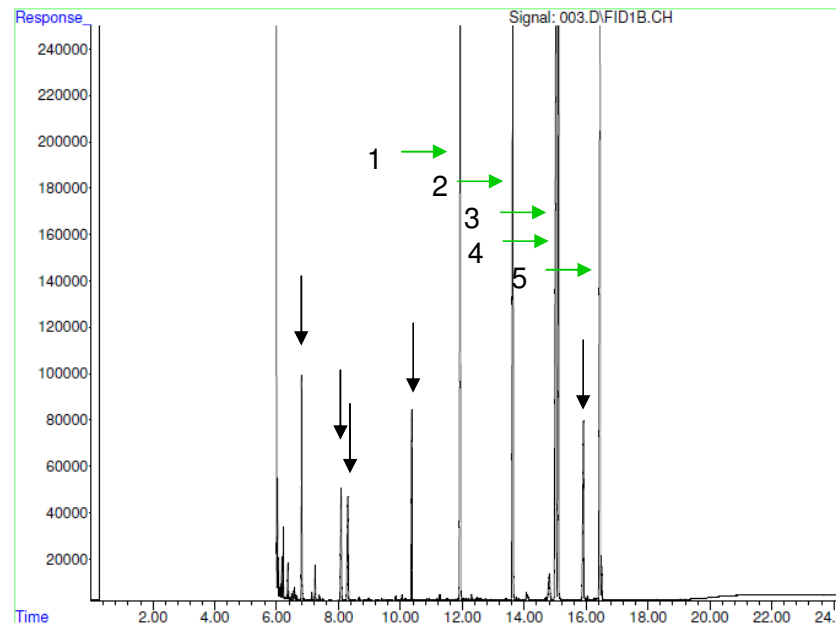

Mineral oil chromatograms – “manual” method vs. LC-GC

Contaminated rice

SPE / LV-GC

LC-GC

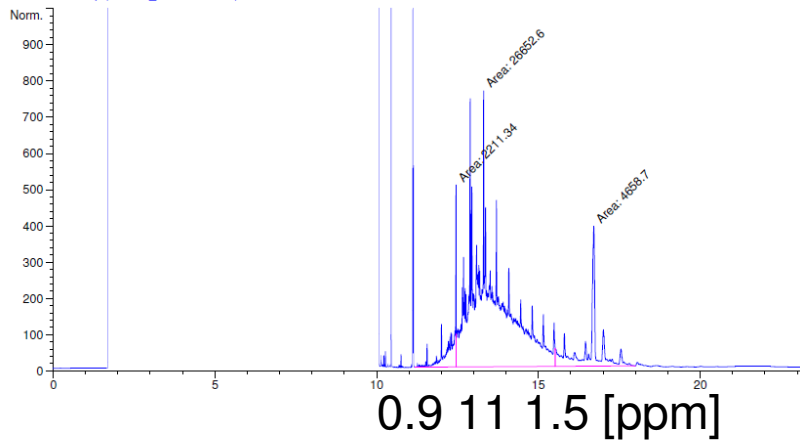

MOSH

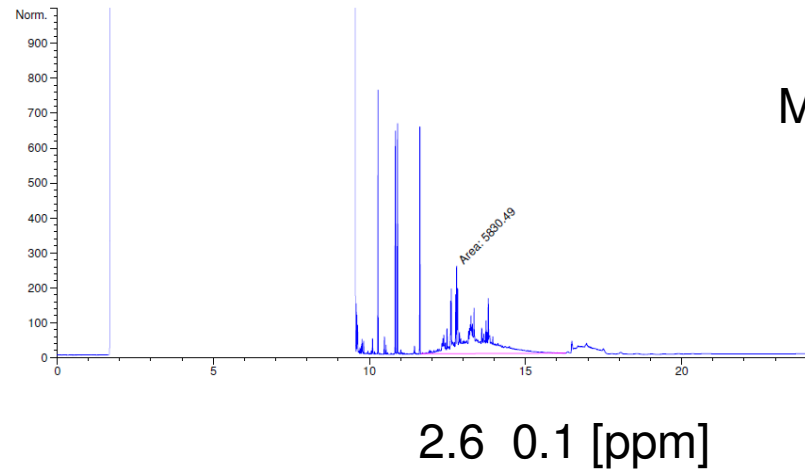
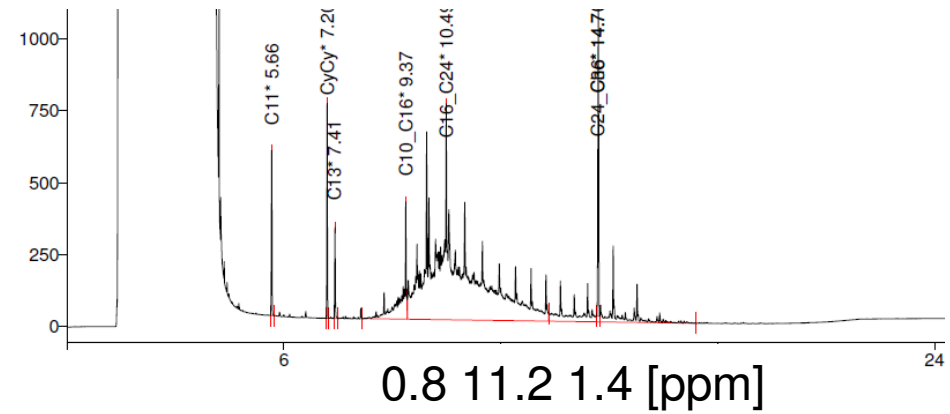

MOAH

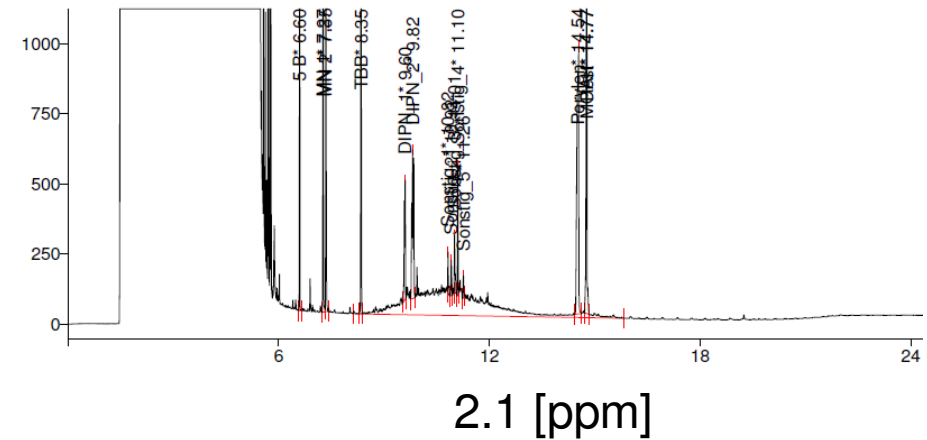

Mineral oil chromatograms – “manual” method vs. LC-GC

Paper board

SPE / LV-GC

LC-GC

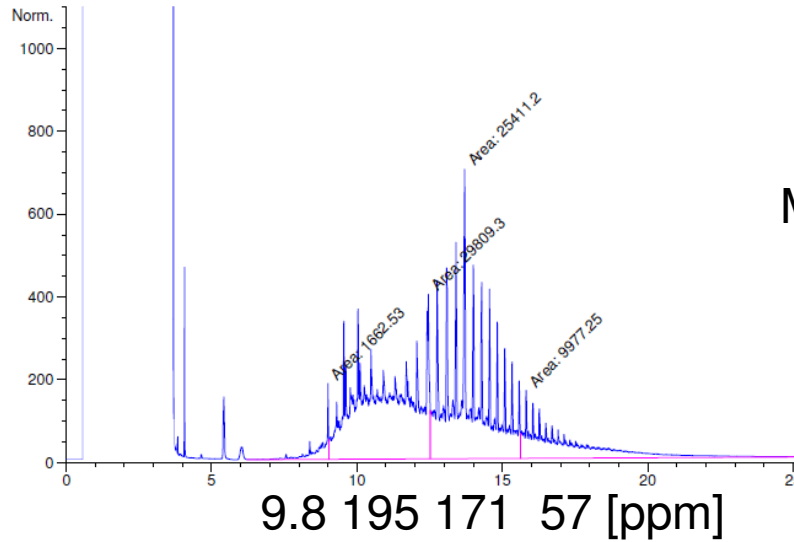

MOSH

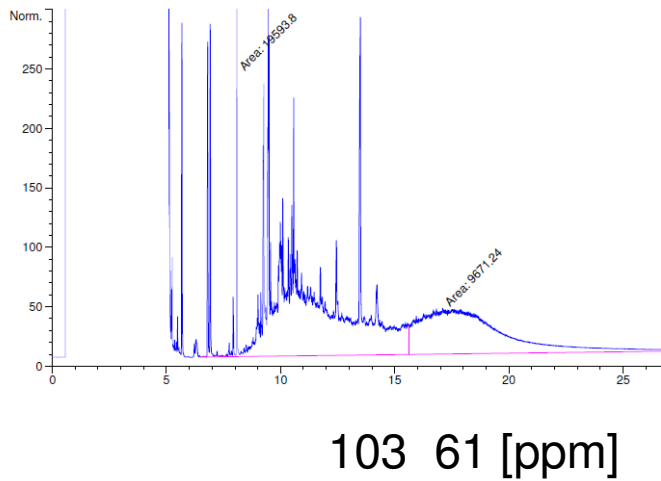
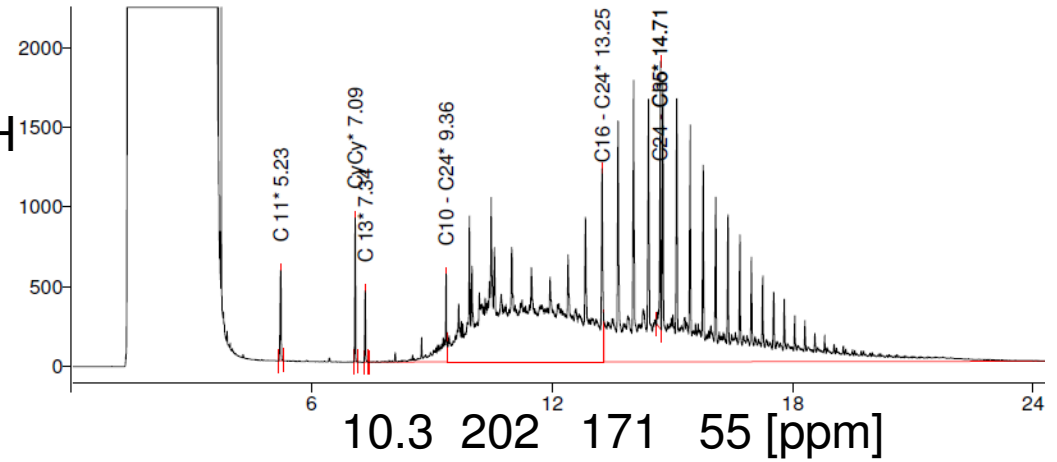

MOAH

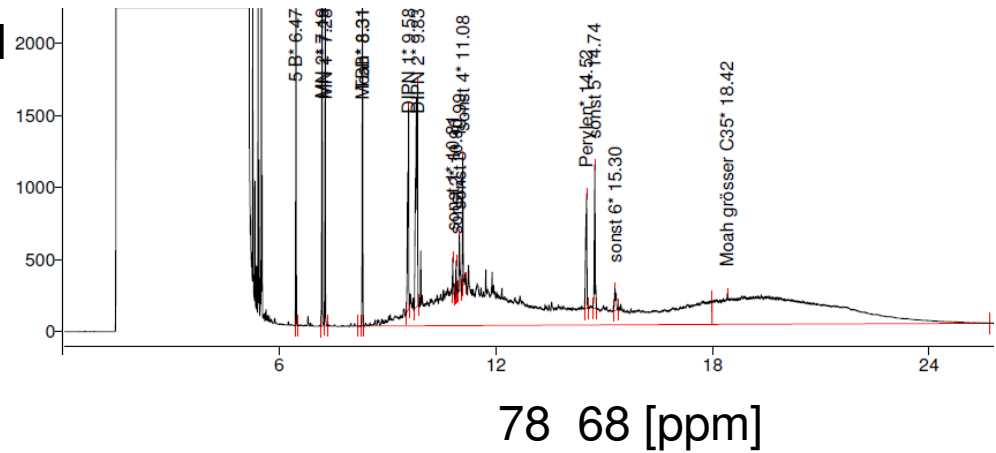

Mineral oil chromatograms – “manual” method vs. LC-GC

Gravex 913 in n-hexane (1000 ppm)

SPE / LV-GC

LC-GC

MOSH

MOAH

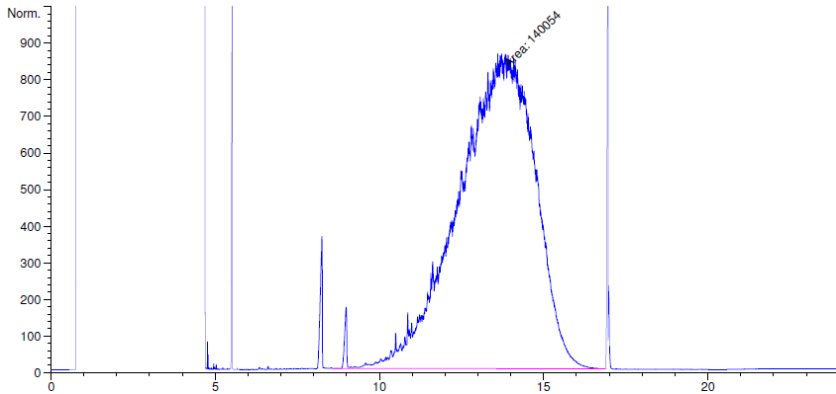

694 [ppm]

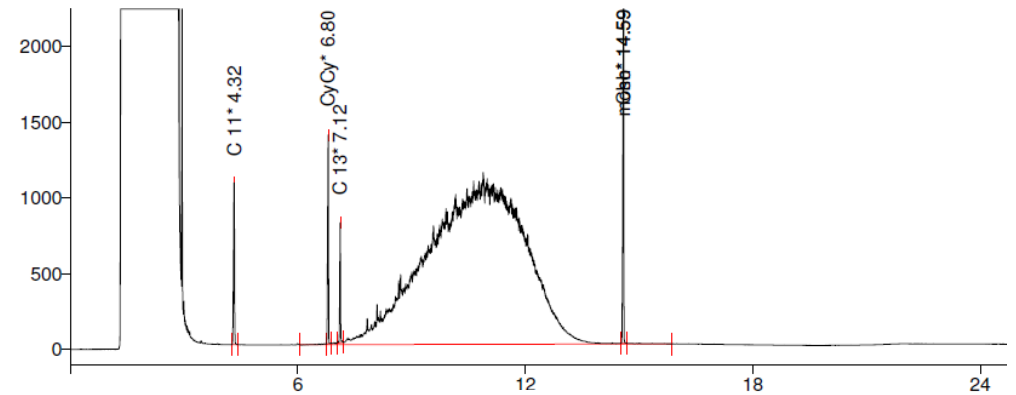

731 [ppm]

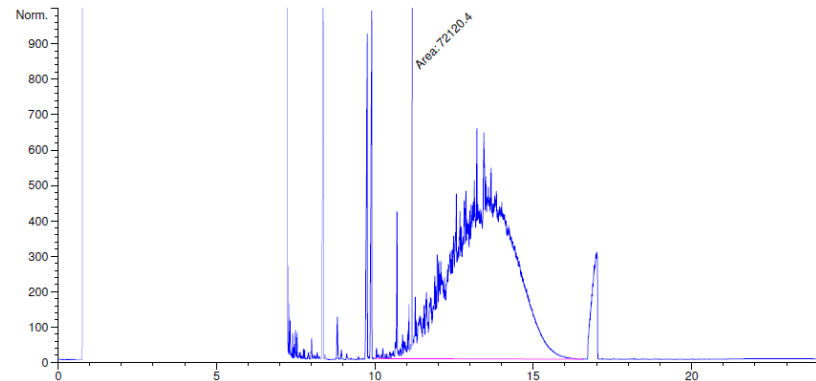

264 [ppm]

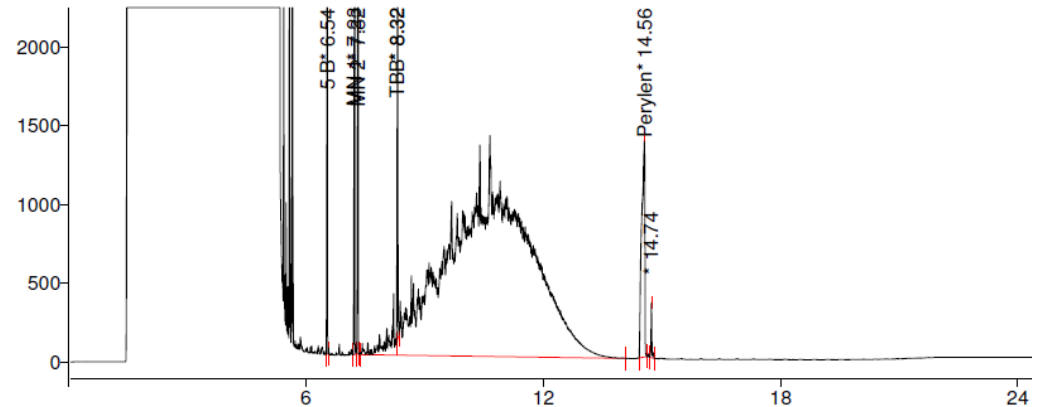

272 [ppm]

Mineral oil chromatograms – “manual” method vs. LC-GC

SPE / LV-GC

Gravex 913 in rapeseed oil (50 ppm)

LC-GC

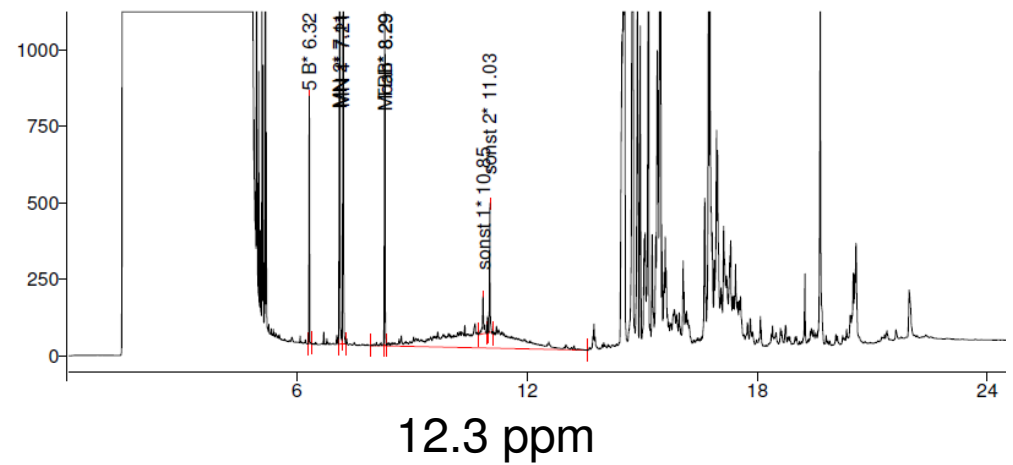
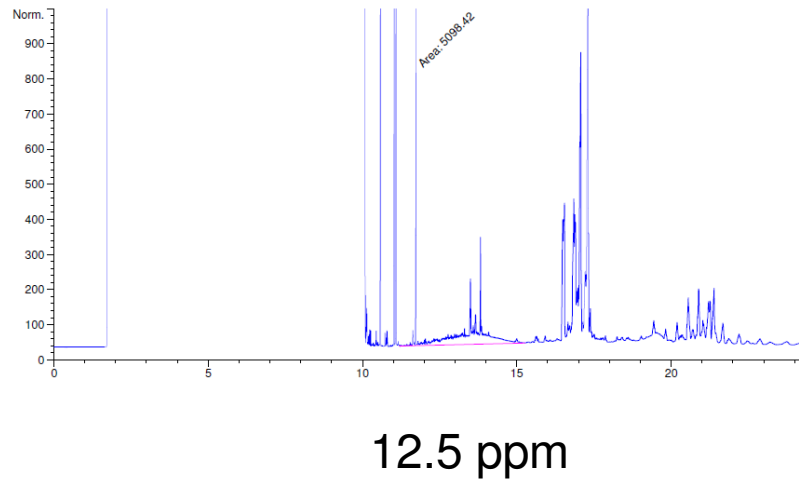
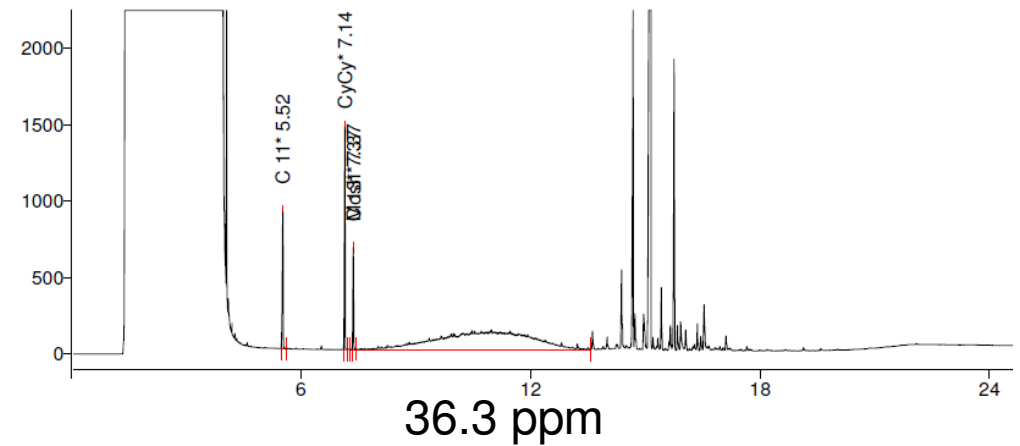
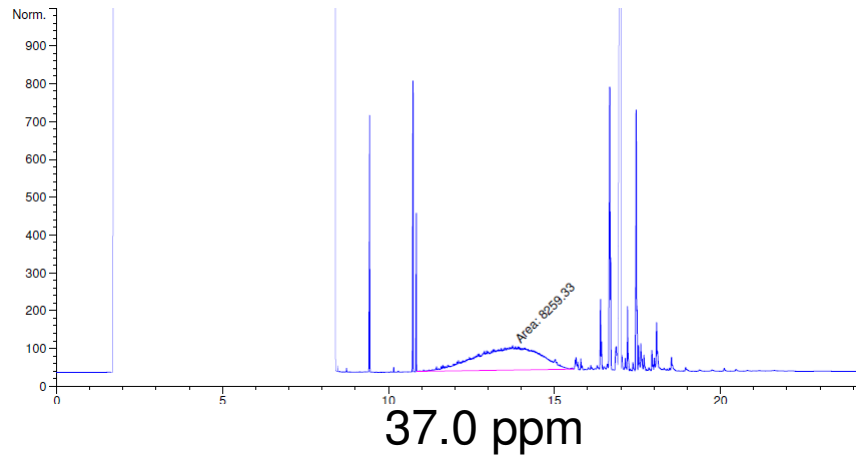

Mineral oil chromatograms – “manual” method vs LC-GC

SPE / LV-GC

Mix of different mineral oils

LC-GC

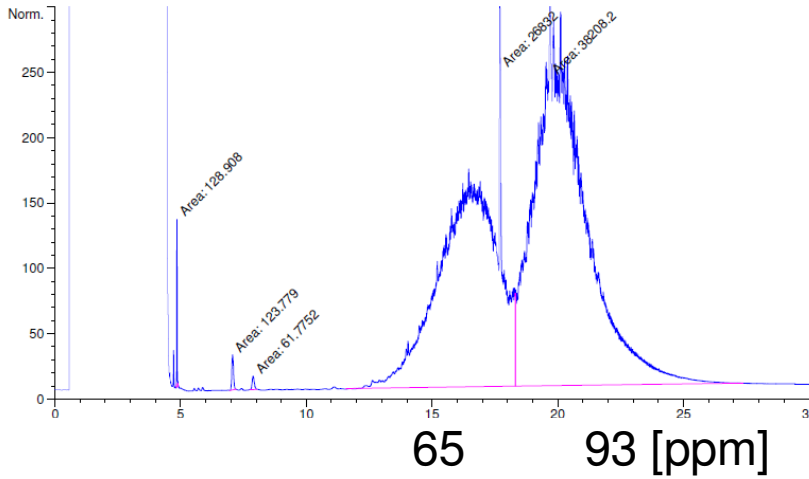

MOSH

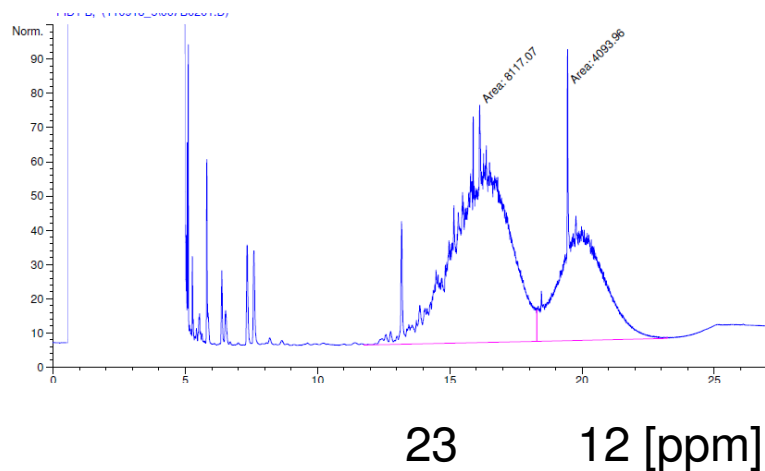
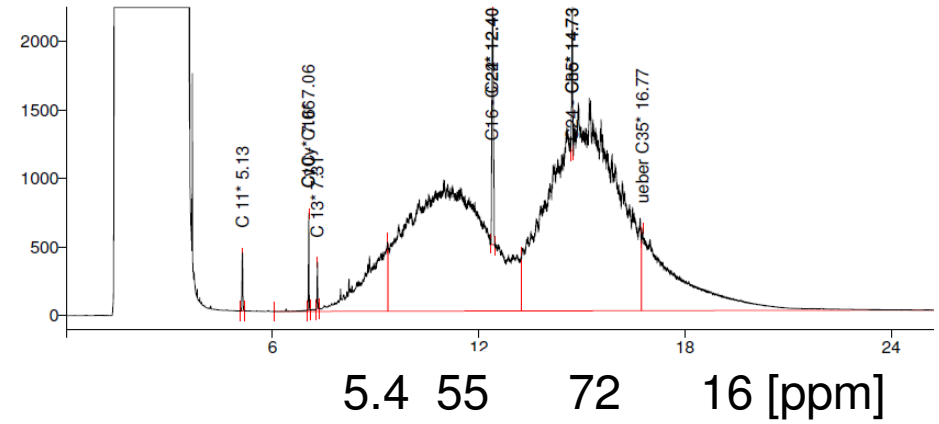

MOAH

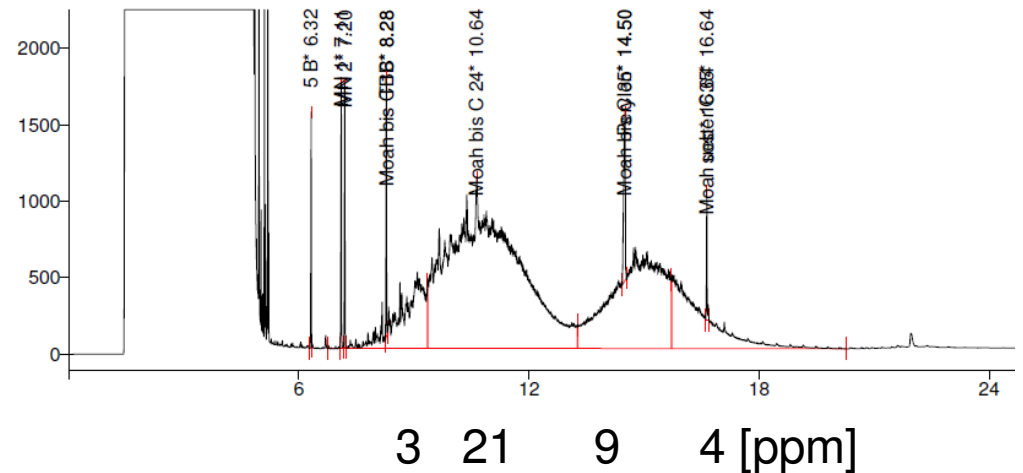

Analysis using on-line HPLC-GC-FID

vs. off-line HPLC

Reproducible and highly resolved separation

- Control by on-line UV-detector

+

Automatable Process

- High efficiency, high sample output
- Highly reproducible results

0

?

Complete Transfer of one HPLC-Fraction into the GC-System

+

→ higher sensitivity

Discrimination-free solvent evaporation during the transfer

-

No loss of volatile mineral oil compounds, no discrimination

Closed system: no cross-contamination of the samples

-

Low solvent consume (<10 mL/sample)

0

Analytical Equipment for the mineral oil analysis (Off-line LC-GC)

Off-line NP-HPLC Sampling

HPLC Agilent Technologies 1100 Series

(Degaser, binary Pump, auto sampler (with Cooling Unit), column oven, UV-detector, fraction collector)

HPLC-column: LiChrospher Si 60 5 μ m; 2 mm x 250mm

Quantification with GC –FID

GC: Agilent 6890

Autosampler: Agilent 6890

GC-Column: DB-1HT (15 m x 0,32 mm x 0,10 μ m) and 7 m
unlined (deactivated) pre column

Injection cool on-column: 40 μ L

MOSH-samples after off-line HPLC-Separation

NP-HPLC with manual or automatic collection of fractions

LV-GC-FID analysis

Literature method needs adaption to our HPLC-system.

MOSH ok

MOAH: Perylene not found, shift in retention time

-> larger volume for MOAH-fractions

Recovery of standards after LC-separation:

Transfer of the published LC-method from LC-GC from Biedermann and Grob (2010)

C 12	109%
C 14	105%
C 16	99%
Cho	104%

9B	101%
6B	103%
TBB	102%
BP	93%
Per	shifted

Off-line HPLC separation of standards

MOSH

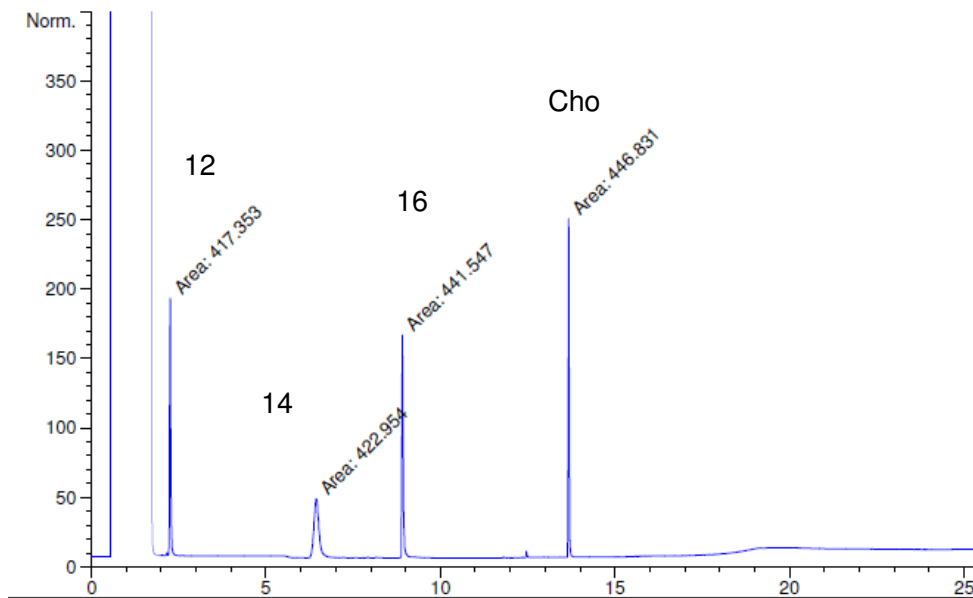

MOAH

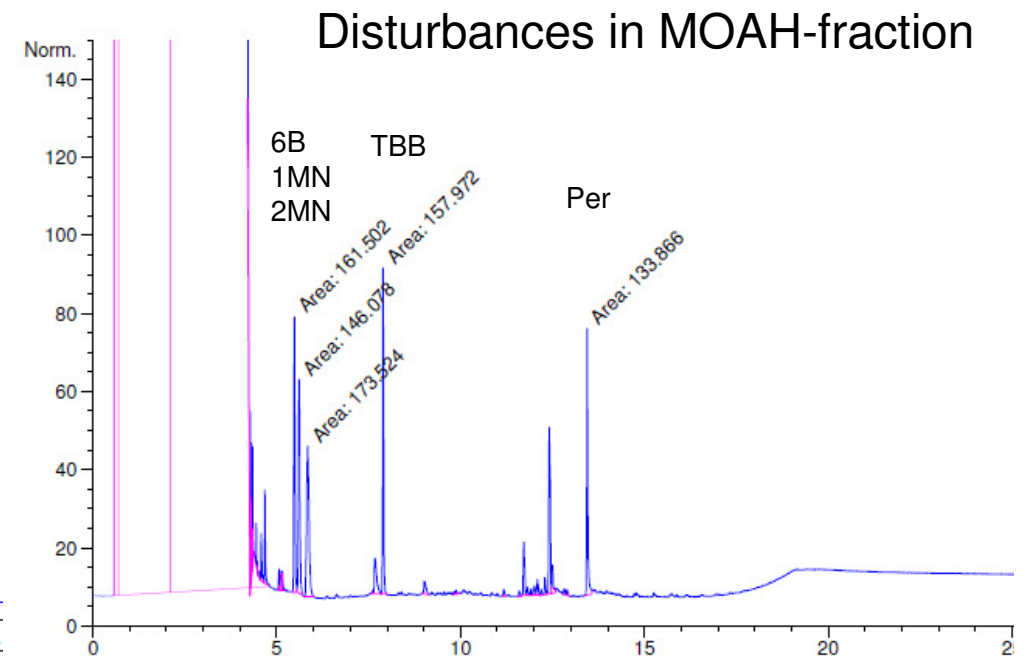

Source of the contaminations in the MOAH-fraction?
Switching valve?

MOSH-samples after off-line HPLC-Separation

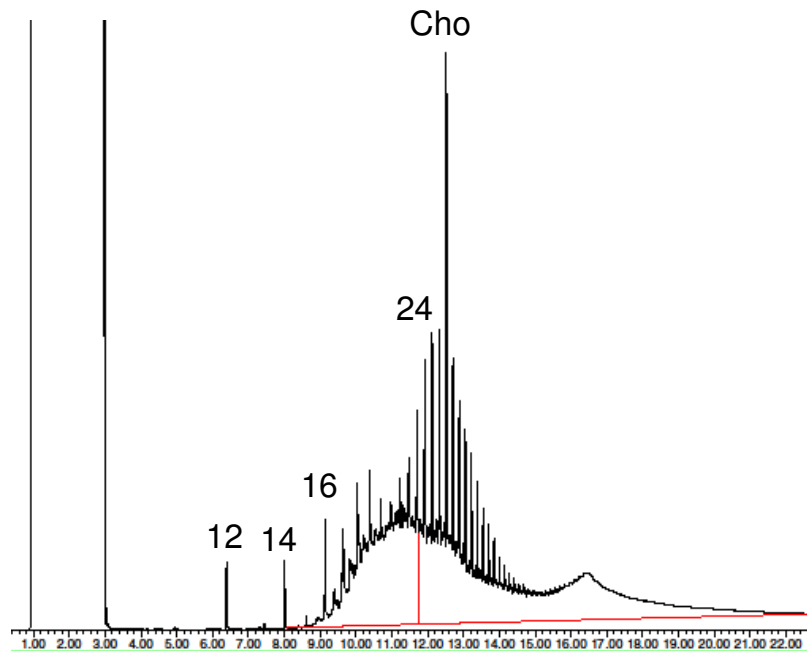

MOSH-
hygiene paper from
recycled material
464 ppm MOSH < C24
776 ppm MOSH > C24

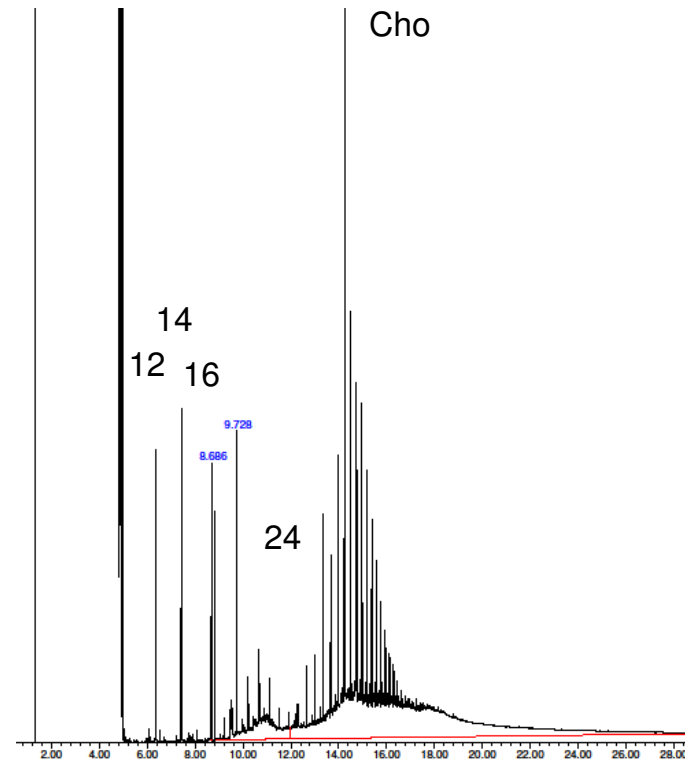

MOSH
Paper board from food packaging
40 ppm MOSH < C24
306 ppm MOSH > C24

MOSH-samples after off-line HPLC-Separation

Possible pitfalls and disadvantages related to offline-HPLC-separation of mineral oil-samples

- Parts of the LC-system may be not stable against DCM
- Up scaling of the column dimensions requires higher flow rates -> higher dilution
- Adaption of the published LC-Method for LC-GC to the used HPLC-System is necessary
- When using a automatic fraction collector, additional tubing (and dead volume) is necessary
-> Chromatographic resolution will decrease
- Need for enrichment before GC-analysis, keeper for evaporisation to avoid loss of volatile compounds
- It's easy to prepare MOSH-fractions with offline-HPLC-separation, **but** for MOAH-analysis more time and effort has to be spent.

Acknowledgement:

7 PD Dr. Dr. A. Luch

72 Dr. K. Pfaff, Dr. B. Vieth, Dr. O. Kappenstein, Dr. J. Heidler,
K. Schön, K. Sernow

73 Dr. F. Tadjine, A. Schameitat, B. Gerding

KLZ Dr. K. Grob, M. Biedermann,
S. Biedermann-Brehm, K. Filsler

KANTONALES LABOR
ZÜRICH



Thank you for your attention

Dr. C. Hutzler

Federal Institute for Risk Assessment

Thielallee 88-92 ● D-14195 Berlin

Tel. +49 30 - 184 12 - 0 ● Fax +49 30 - 184 12 - 47 41

bfr@bfr.bund.de ● www.bfr.bund.de

christoph.hutzler@bfr.bund.de

● Tel. +49 30 18412 3782